

Installation and Operation Instructions

1200°C Split Tube Furnace - TS1/3 1200mm ø125mm

TS1 12/125/1200 + TS3 12/125/1200

Contents

This manual is for guidance on the use of the Carbolite Gero product specified on the front cover. This manual should be read thoroughly before unpacking and using the furnace or oven. The model details and serial number are shown on the back of this manual. Use the product for the purpose for which it is intended.

1.0	Introduction	5
1.1	Scope and Purpose	5
1.1.1	Responsibilities	5
1.2	Prerequisites to Use	5
2.0	Safety	7
2.1	Symbols and Warnings	7
2.2	Operator Safety	8
2.3	Risk Prevention and Mitigating Residual Risks	8
2.4	Safety Warning - Refractory Fibre Insulation	9
3.0	Product Overview	10
3.1	Product Rating Label	10
3.2	Part Identification	11
3.3	Control Box Input / Output Identification	12
3.4	Product Labels	13
3.5	Dimensions	14
4.0	Specifications	17
4.1	Options and Accessories	17
5.0	Electrical Specifications	18
5.1	Fuses and Power Settings	18
5.2	Operating / Storage Environment	19
6.0	Options and Accessories	20
6.1	Work Tube End Seals	20
6.2	Insulation Plugs / Radiation Shields	22
6.2.1	Insulation Plug / Radiation Shield Installation	23
6.3	Probe Thermocouple (Optional)	23
6.3.1	Cascade Control	23
6.4	Inert Gas Package (Standard / Advanced)	24
6.5	Gas Safety System	25
7.0	Installation	26
7.1	Manual Handling	26
7.1.1	Sling Guides	26

7.2	Unpacking	27
7.2.1	Vertical Orientation:	27
7.3	Siting and Setting Up	27
7.4	End Guard Installation	29
7.5	Work Tube Installation	30
7.6	Lid Prop	31
7.7	Insulation Collar Replacement	33
7.8	Work Tube Supports	37
7.8.1	Horizontal Orientation	37
7.8.2	Vertical Orientation (Vertical Stand and Vertical Tube Support Package Only)	37
7.9	Pneumatic Strut Replacement	41
7.10	Mounting the Furnace on the Vertical Stand	42
7.11	Securing Vertical Stands to a Surface	44
7.11.1	Horizontal Surface	44
7.12	Electrical Connections	46
7.12.1	1-Phase Connections	46
7.12.2	3-Phase Connections	47
7.13	Mains Supply Cable	47
7.14	Connecting a Supply Cable to Internal Terminals	47
8.0	Commissioning	49
8.1	Pre-Commissioning	49
8.2	Commissioning - Initial Function Checks	50
9.0	Temperature Controller	52
10.0	Operation	53
10.1	Operating Cycle	53
10.2	Safe Operation	54
10.3	Recommendations for Work Tube Usage	55
10.3.1	Inserting Work Pieces and Samples	55
10.3.2	Running at High Temperatures	55
10.3.3	Heating Rates	55
10.4	Insulation Cracking	55
10.5	Pressure	56
11.0	Maintenance	57
11.1	General Maintenance	57
11.2	Maintenance Schedule	57
11.3	Cleaning	59

11.4	Safety Switch	59
11.5	Calibration	60
11.6	After-Sales Service	60
11.7	Recommended Spare Parts and Spare Parts Kit	60
11.8	Maintenance Manual	60
12.0	Fault Analysis	61
A.	Furnace Does Not Heat Up	61
B.	Product Overheats	62
13.0	Decommissioning, Storage and Disposal	63
13.1	Decommissioning	63
13.2	Storage (Long Term)	63
13.3	Disposal	63
14.0	Declaration of Conformity	64

1.0 Introduction

1.1 Scope and Purpose

This product is intended to be used within a laboratory environment for the processing or testing of materials at high temperatures. It is intended that a work tube is fitted within the furnace and that materials are placed within the work tube for processing.

It must be installed, commissioned, and operated in accordance with the instructions contained within this manual, and only by trained personnel.

For maintenance instructions, please contact Carbolite Gero to request the separate "Maintenance Manual".



Note: If this product is used for any application other than its intended purpose, as stated by Carbolite Gero, the protection provided by this equipment may be impaired.

Note: Failure to comply with the instructions as stated within this manual will constitute misuse and subsequently void any warranty provided by Carbolite Gero.

1.1.1 Responsibilities

The customer is responsible for conducting their own risk assessment and ensuring that any materials to be processed within the product are suitable to be safely heated to the required temperature, and that appropriate safety measures are taken when handling such materials:

- Any material that is combustible or liable to cause explosions or generate combustible gas must not be processed unless the product is supplied with specialist equipment designed to manage such reactions
- The customer must provide an adequate ventilation and fume extraction system to manage any fumes given off by materials during processing

This product should not be modified or used for any purpose other than that for which it is intended.

1.2 Prerequisites to Use

Prior to the commissioning and use of this product, all personnel involved in its installation, operation and maintenance must be deemed competent and have:

- Read and understood the information contained within this manual
- Received the relevant training with regard to safety and operation of the product
- Been provided with the appropriate PPE (Personal Protective Equipment) required for the safe operation of this product

Note: The customer is responsible for ensuring that all of the above conditions are satisfied before the product is commissioned for use.



Note: Unless otherwise specified, the customer is responsible for the installation of this product and the safe connection of any additional equipment and gas or liquid supply lines.











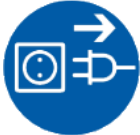









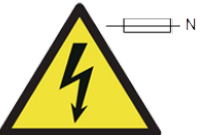

Note: Throughout this manual, written instructions are accompanied by diagrams. Diagrams may be highlighted in different colours and do not reflect the actual colouration of the product. Parts that are to be moved are highlighted in **YELLOW** and are intended to be fixed to, or removed from, surfaces highlighted in **BLUE**. Where applicable, arrows show the direction of movement.

2.0 Safety

2.1 Symbols and Warnings

Note: Observe and take the appropriate precautions if any of the following warning symbols are displayed on this product or in your working environment.

	Refer to the instruction manual before operating or maintaining the equipment		Disconnect the product from the power supply before performing any maintenance
	Wear eye protection		Wear a heat-resistant face shield
	Wear heat-resistant gloves		Wear breathing apparatus
	Wear protective footwear		Wear protective clothing
	Minimum of 2 people required to lift		DANGER: Heavy load. Specialist equipment required!
	WARNING!		DANGER: Risk of electric shock!
	DANGER: Fire risk!		DANGER: Hot surface!
	CAUTION: Double Pole/ Neutral Fusing!		DANGER: Explosive materials / atmosphere!
	DANGER: Suspended loads!		





	DANGER: Risk of slipping!		DANGER: Risk of crushing injury!
	WARNING: Adequate ventilation required!		DO NOT dispose! Recycle according to WEEE Regulation guidelines!
	Any action noted beside this symbol is strictly forbidden!		DO NOT use this product to cook or heat food or beverages!

2.2 Operator Safety

Note: It is the responsibility of the customer to ensure that all personnel required to operate this product are fully trained and equipped with the appropriate PPE (Personal Protective Equipment).

Carbolite Gero recommend that the appropriate PPE is worn at all times whilst working with and around this product.

2.3 Risk Prevention and Mitigating Residual Risks

Risk		Prevention Measures
	Hot Surface	<ul style="list-style-type: none"> Wear appropriate PPE e.g. heat resistant gloves Do not place any objects on top of the product Ensure the product is sited on a non-flammable surface, and that all adjacent surfaces are also non-flammable
	Ventilation required	<ul style="list-style-type: none"> Only operate in a well ventilated area If necessary, only operate in a fume cupboard
	Fire / Explosion	<ul style="list-style-type: none"> Only trained operators should use this equipment Only process materials for which a suitable risk assessment has been carried out
	Exposure to hazardous material	<ul style="list-style-type: none"> Wear appropriate PPE e.g. protective gloves, dust masks, eye protection Avoid breaking up insulation material Please refer to section 2.4 for further details If in doubt, please contact Carbolite Gero Service

2.4 Safety Warning - Refractory Fibre Insulation



Insulation made from High Temperature Insulation Wool Refractory Ceramic Fibre, better known as (Alumina silicate wool - ASW).

This product contains **alumino silicate wool** products in its thermal insulation. These materials may be in the form of blanket or felt, formed board or shapes, slab or loose fill wool.

Typical use does not result in any significant level of airborne dust from these materials, but much higher levels may be encountered during maintenance or repair.

Whilst there is no evidence of any long term health hazards, it is strongly recommended that safety precautions are taken whenever the materials are handled.

Exposure to fibre dust may cause respiratory disease.

When handling the material, always use approved respiratory protection equipment (RPE-eg. FFP3), eye protection, gloves and long sleeved clothing.

Avoid breaking up waste material. Dispose of waste in sealed containers.

After handling, rinse exposed skin with water before washing gently with soap (not detergent). Wash work clothing separately.

Before commencing any major repairs it is recommended to make reference to the European Association representing the High Temperature Insulation Wool industry (www.ecfia.eu).

Further information can be provided on request. Alternatively, Carbolite Gero Service can quote for any repairs to be carried out either on site or at the Carbolite Gero factory.

3.0 Product Overview

3.1 Product Rating Label

The product rating label is located on the side of the product control box.

Note: The image below is an example and does not reflect the product(s) covered by this manual.

UK CA	Carbolite GERO Ltd, Parsons Lane, Hope, Hope Valley, S33 6RB www.Carbolite – Gero.com		CE
	Country of Origin United Kingdom		
Type	TS 12/60/600	Manufactured	2020
	Serial No. 22-001028	Max Temp 1200°C	Power 2340 W
	Frequency 50-60 Hz	Volts 240 V	Phases 1
			Current 16.0 A

1	UKCA Mark
2	Carbolite Gero address and website
3	CE Mark
4	Country of Origin
5	Product Model
6	Year of Manufacture
7	Dispose of according to WEEE regulations (Waste Electrical and Electronic Equipment Directive)
8	Product Serial Number
9	Maximum Temperature
10	Power Rating
11	Frequency (Hertz)
12	Design Voltage
13	Design Phases
14	Current (Amps)



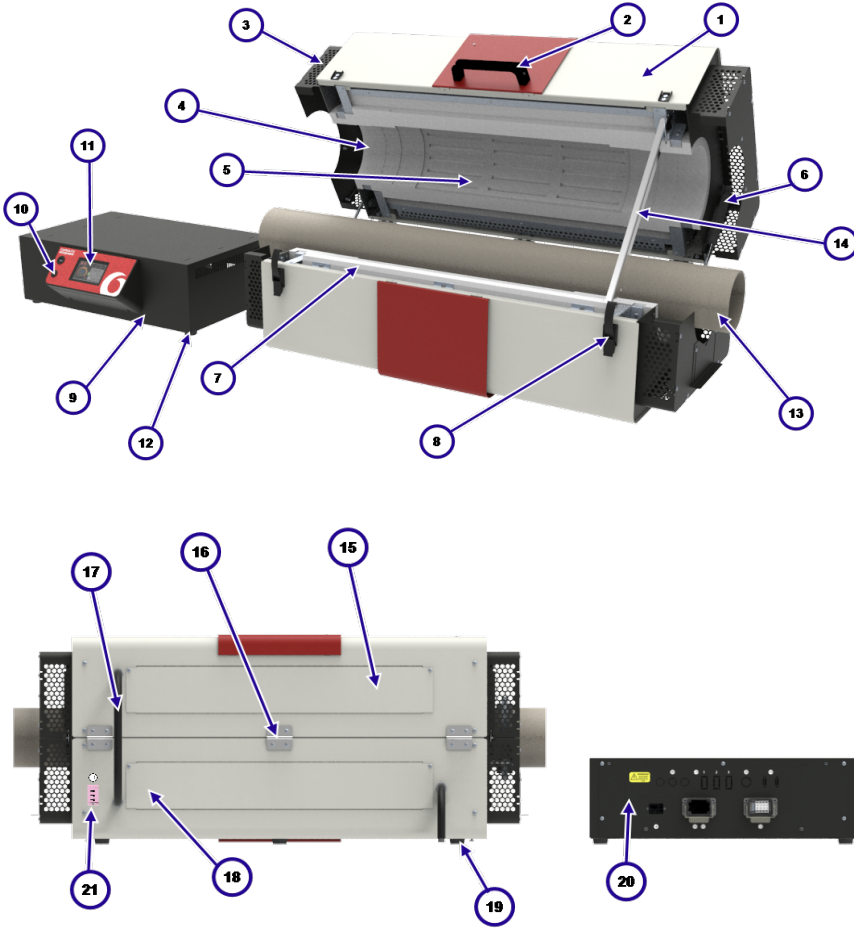



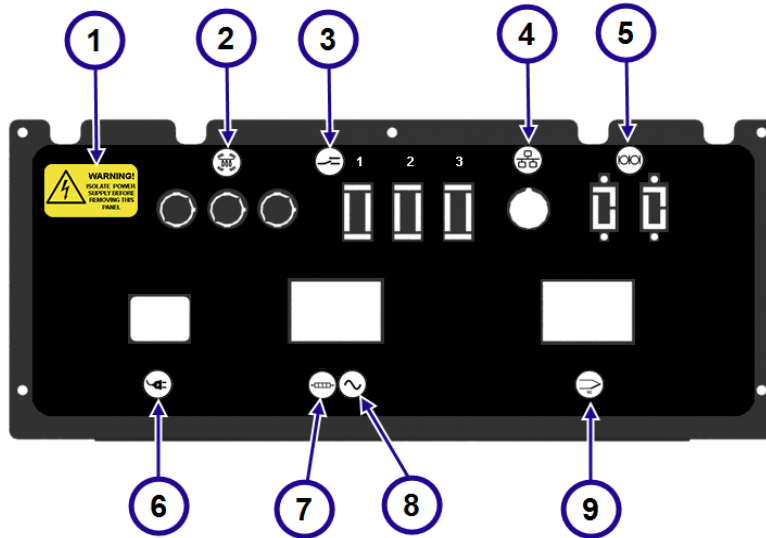

3.2 Part Identification



1	Outer Casing
2	Handle
3	End Guards
4	Insulation Collar
5	Heating Element
6	Pneumatic Strut
7	Insulation Bar
8	Door Latch
9	Control Box
10	Instrument Switch
11	Controller
12	Control Box Foot
13	Work Tube
14	Lid Prop
15	Heating Element Access Panel (1)
16	Hinge
17	Electrical Conduits
18	Heating Element Access Panel (2)
19	Furnace Foot
20	Electrical Component Access Panel
21	Probe Thermocouple Socket (Cascade Control option only)

3.3 Control Box Input / Output Identification

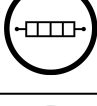

1	 WARNING! ISOLATE POWER SUPPLY BEFORE REMOVING THIS PANEL	Warning! Isolate power supply before removing this panel!
2		Heating Lamps
3		Relay Inputs (optional)
4		Ethernet Communication Port
5		Serial Communications Port(s) (optional)
6		Power Supply Input
7		Power Output to Heating Elements
8		Alternating Current (AC)
9		Thermocouple Input

3.4 Product Labels

Before commissioning this product, ensure that the following product information and warning labels are in the positions detailed below:

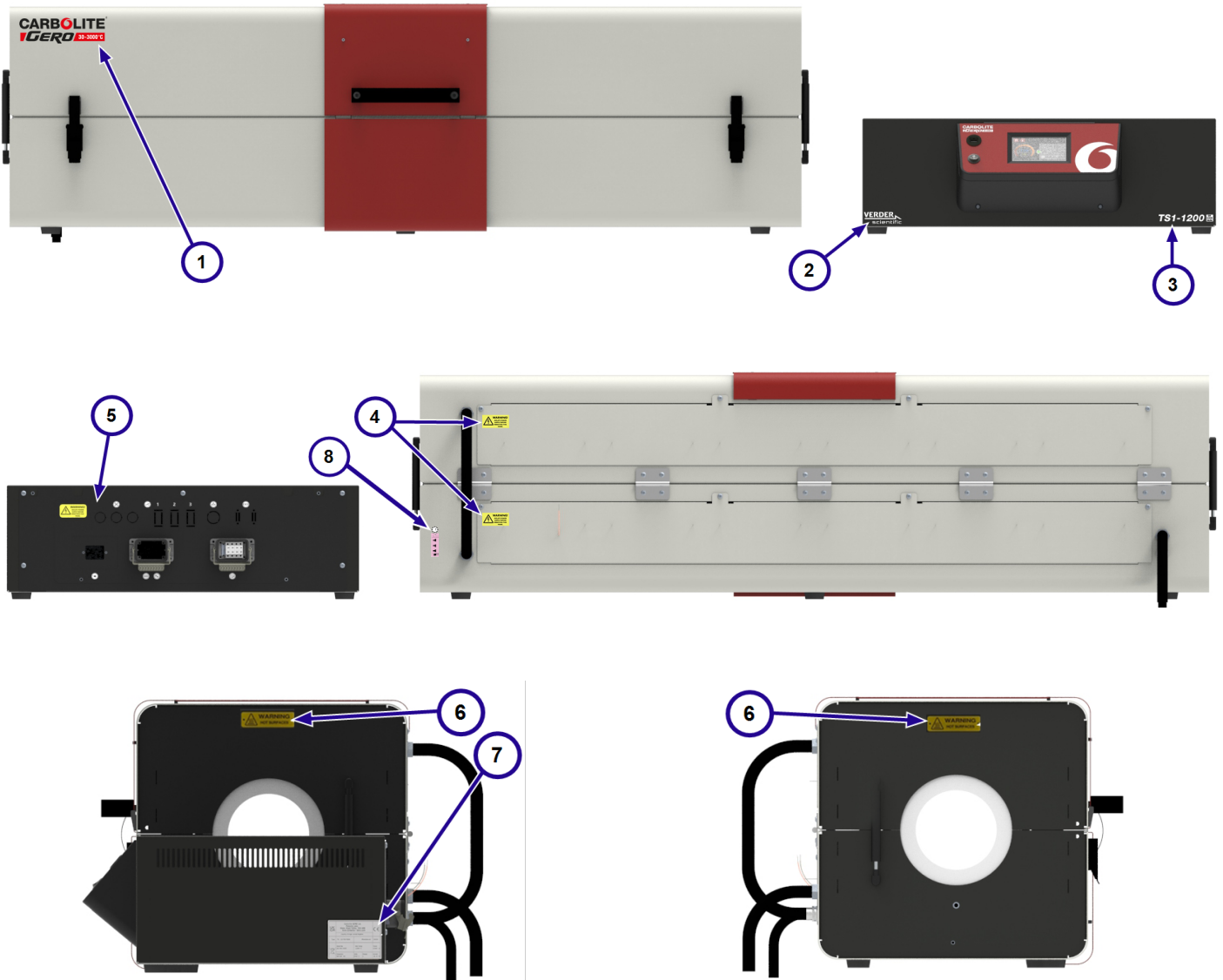

1	Carbolite Gero Logo
2	Verder Scientific logo
3	Product ID Label
4	WARNING: ISOLATE POWER SUPPLY BEFORE REMOVING THIS PANEL
5	Electrical Component Access Panel Label
6	WARNING: HOT SURFACES
7	Product Rating label
8	Probe Thermocouple Socket Label (Cascade Control Option Only)

3.5 Dimensions

AA	Maximum opening angle
A	Maximum height (open)
B	Maximum depth (open)
D	Height of control box
E	Height of furnace case (closed)
F	Minimum depth for control box conduits
G	Depth of control box
H	Depth of furnace case
J	Maximum work tube length
K	Width of control box
L	Width of furnace case
M	Width with end guards
N	Depth of handle
P	Stand base width
Q	Stand base depth
R	Stand height
S	Maximum height on stand
T	Minimum clearance under work tube
V	Centre-line height
W	Maximum depth (open, vertical)
X	Minimum depth for furnace conduits
Y	Height of stand base

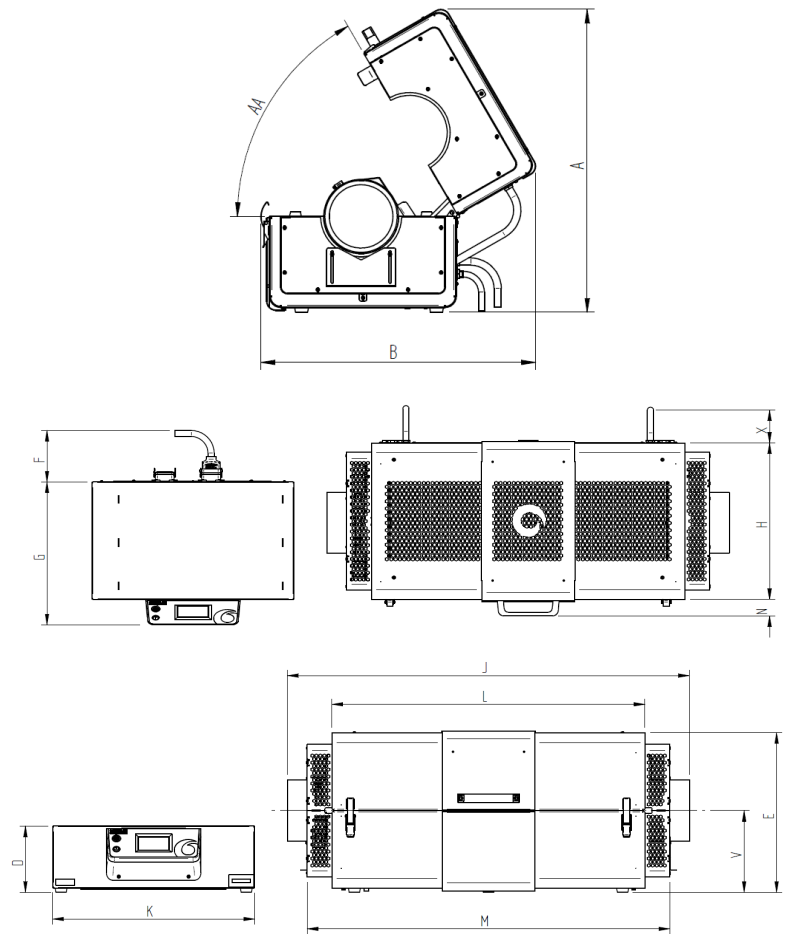

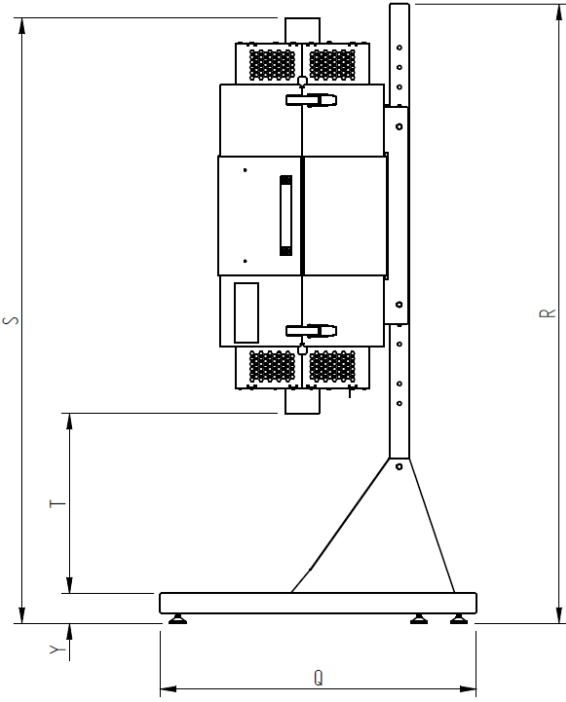
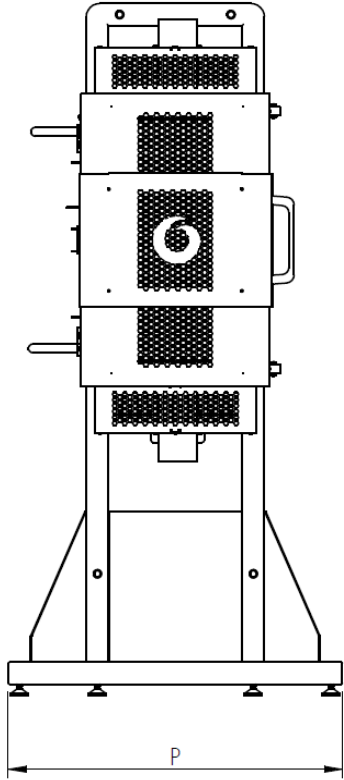
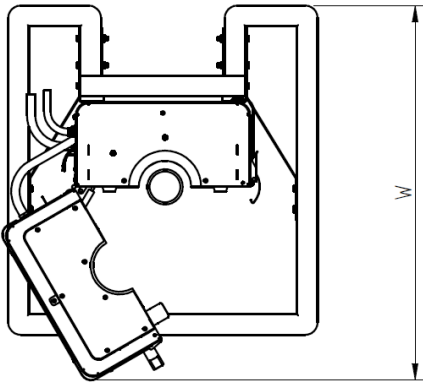
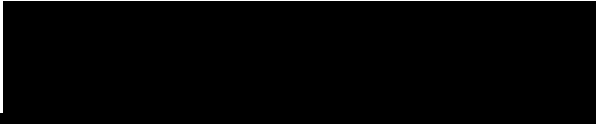

Note: Dimension AA is measured in degrees (°). Dimensions A-Y are measured in millimetres (mm).

AA	A	B	D	E	F	G	H	J	K	L	M	N	P	Q	R	S (min)	S (max)	T (min)	T (max)	V	W	X	Y
60	704	651	228	445	591	473	431	1800	653	1463	1678	51	500	575	2213	2190	2390	314	514	233	910	90	76

Note: It is possible to mount the furnace on the vertical stand at several different height positions (typically at 50mm increments), therefore dimensions **S** and **T** are variable depending on the position of the furnace on the stand. The "Min" and "Max" values represent the furnace mounted at the highest and lowest possible positions. Please contact Carbolite Gero for assistance.

4.0 Specifications

Furnace	
Maximum Temperature (°C)	1200
Maximum Continuous Operating Temperature (°C)	1100
Maximum Power (kW)	4.46
Net Weight (kg)	134
Heated Length (mm)	1200
Minimum recommended work tube length (mm)	1550
Maximum recommended work tube length (mm)	1800

Control Box	
Height x Width x Depth (mm)	
Net Weight (kg)	16

4.1 Options and Accessories

Vertical Stand	
Height x Width x Depth (mm)	2213 x 750 x 800
Net Weight (kg)	56.4

5.0 Electrical Specifications



This equipment **MUST** be earthed!

Product Ingress Protection (IP) Rating: 20

5.1 Fuses and Power Settings

Phases	Voltage (V)	Main Fuse (Amps, Type, Size)	Power Turndown (%)
1 phase + Neutral	110	-	-
	120	-	-
	208	25, gG, 10x38mm	100
	220	25, gG, 10x38mm	89
	230	25, gG, 10x38mm	82
	240	25, gG, 10x38mm	75
3 phase + Neutral	380	16, gG, 10x38mm	89
	400	16, gG, 10x38mm	82
	415	16, gG, 10x38mm	75
3 phase (No Neutral)	208	16, gG, 10x38mm	100
	240	16, gG, 10x38mm	75

Note:

All auxiliary fuses on standard models are rated at **2 Amps** and should only be replaced with fuses of the following specification: **F2A HBC 5x20mm**.

Auxiliary fuses for models ordered with the Advanced Inert Gas Package are rated at **5 Amps** and should only be replaced with fuses of the following specification: **T5A HBC 5x20mm**.

Note: If the product is fitted with a detachable mains supply cable, **DO NOT** replace the cable with one that does not meet the rating standards required above.

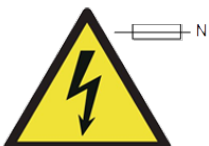

Double Pole Neutral Fusing may be used in this product to protect against faults caused when it is possible to reverse the polarity of the connection to the power supply e.g. in countries that have 2-pin plugs that could be connected "either way".

5.2 Operating / Storage Environment

The products covered by this manual contain electrical parts and should be stored and used in indoor conditions as follows:

Temperature:	5°C - 40°C
Relative humidity:	Maximum 80% up to 31°C decreasing linearly to 50% at 40°C
Altitude:	Not exceeding 2000 metres

6.0 Options and Accessories

Note: Any additional equipment to be used with this product should be supplied by Carbolite Gero. Accessories from third-party sources are not designed to Carbolite Gero's specifications and may result in poor performance, damage to equipment or dangerous working conditions.

6.1 Work Tube End Seals

Work tube end seals are attached to both ends of a work tube in order to contain a modified atmosphere (gas or vacuum).

A standard end seal assembly is made up of the following components:

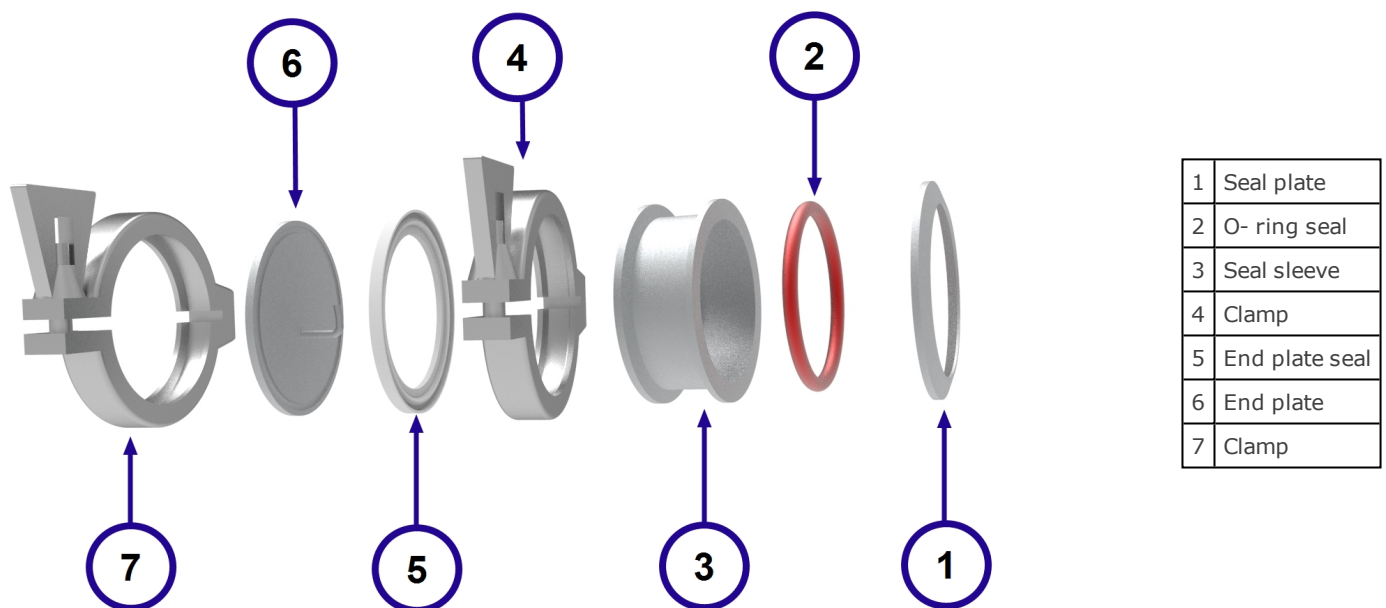

Note: Depending on the work tube package ordered, the end plate may have gas inlet / outlet pipes, thermocouple glands and/or vacuum fittings.

To fit the end seal assembly to a work tube:

- Place the seal plate over the end of the work tube as shown.

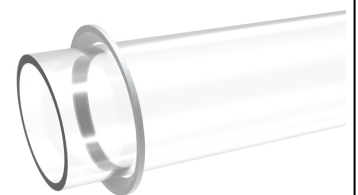

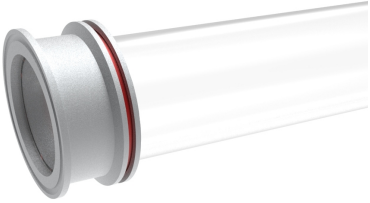
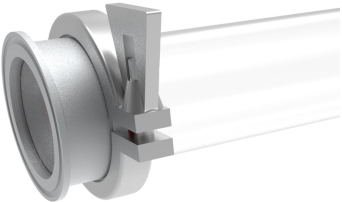
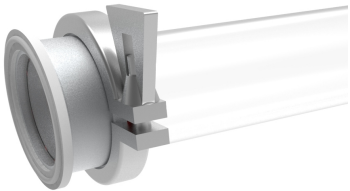
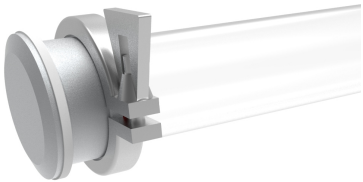
<ul style="list-style-type: none">Carefully push the O-ring seal over the work tube and flush against the seal plate. The O-ring should fit within the taper of the seal plate.	
<ul style="list-style-type: none">Slide the seal sleeve over the work tube until the end is flush against the end of the work tube.It may be necessary to adjust the positioning of the O-ring seal and seal plate in order to allow the seal sleeve to fit completely over the work tube.	
<ul style="list-style-type: none">Secure the seal sleeve and seal plate in position with a clamp.Carefully tighten the clamp so that the seal sleeve and seal plate do not slip around the work tube.	
<ul style="list-style-type: none">Push the end plate seal onto the groove on the end of the seal sleeve.	
<ul style="list-style-type: none">Push the end plate onto the end of the assembly. It may be necessary to hold it in position until it is secured with a clamp.	

- Secure the end plate to the end of the seal sleeve with the remaining clamp.

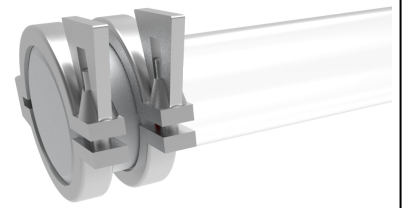

6.2 Insulation Plugs / Radiation Shields



Note: Insulation plugs are constructed from refractory fibre materials and should be treated with great care; always wear appropriate PPE when handling. Insulation materials become brittle and more likely to crack and disperse fibres once heated. Refer to section 2.4 for more information.

Insulation plugs / radiation shields help to increase temperature uniformity whilst preventing excessive levels of heat from escaping out the ends of the work tube, which could damage the end seals (if fitted) or surrounding environment. They also provide the added benefit of gradually reducing the temperature difference (temperature gradient) between the heated section and cooler ends of the work tube, thus reducing the risk of thermal shock damage.

1	Hanger		
2	Stem		
3	Thermocouple access groove		
4	Insulation material		
5	Radiation shields		
		<i>Insulation Plug</i>	<i>Radiation Shield</i>

Note: Insulation plugs and radiation shields will vary in appearance, depending on the tube furnace size and model.

6.2.1 Insulation Plug / Radiation Shield Installation

- The hanger at the end of the each insulation plug should be level with the end of the work tube. If using the work tube package for air, holes in the ends of the hangers allow them to be secured to the support brackets using screws.

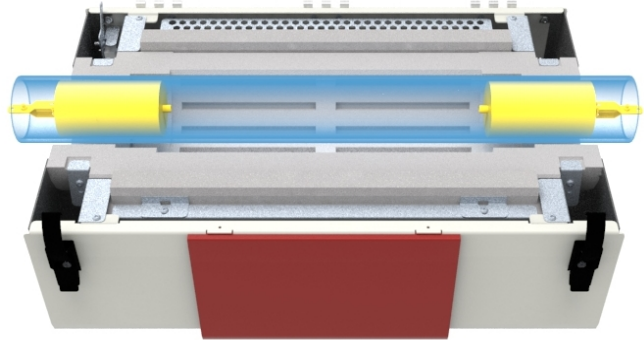

Example: Work Tube Package for Air Atmosphere

- If using end seals, the hanger at the end of each insulation plug / radiation shield stem should be connected to the hook on the inside of the end plate. This will ensure correct positioning within the work tube.

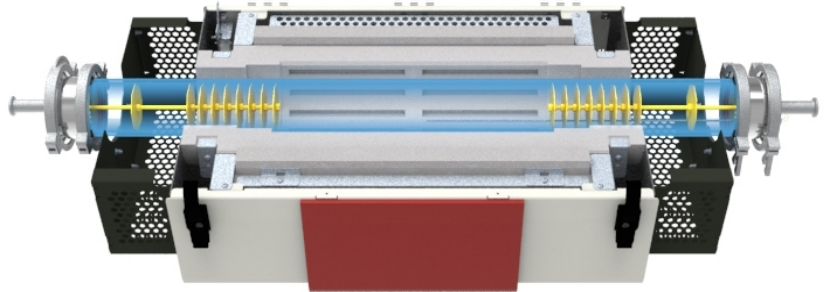

Example: Work Tube Package for Vacuum Atmosphere

6.3 Probe Thermocouple (Optional)

Probe thermocouples enable operators to record more accurate temperature readings inside a heated vessel (work tube, retort, reactor etc.).

A probe thermocouple can be plugged into an independent external temperature reader.

6.3.1 Cascade Control

Furnaces configured to operate via cascade control always require a probe thermocouple.

The operator inputs a setpoint temperature into the controller; this is the temperature that they desire inside the heated vessel, which is measured by the probe thermocouple. The temperature of the heating elements is measured by a separate, built-in thermocouple. The temperature controller reads both thermocouples and calculates the amount of power required to reach the setpoint.

Products ordered with cascade control have a socket at the rear of the furnace body into which the probe thermocouple can be connected.

To connect the probe thermocouple for cascade control:

Note: Ensure that there is sufficient space at the side of the furnace to allow for the easy insertion and withdrawal of probe thermocouples.

- Gently twist the compression nut, part of the thermocouple gland on the end of the work tube end plate to loosen the seal and allow for thermocouple access.
- Carefully insert the probe thermocouple through the gland.
- Securely tighten the gland to ensure that the thermocouple remains in position and that any atmosphere contained inside the work tube does not escape.

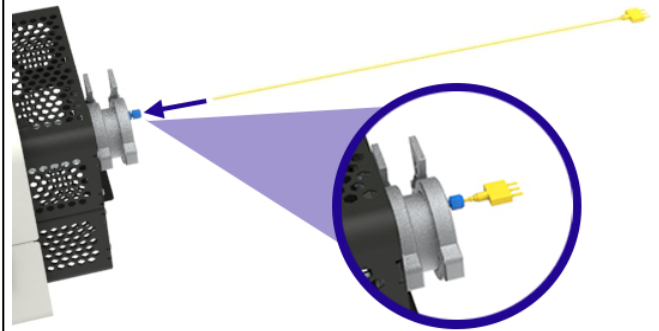

- Connect the male end of the thermocouple lead to the socket at the rear of the furnace body.

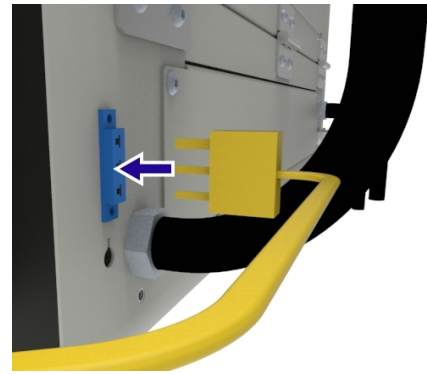

- Connect the female end of the lead to the end of the thermocouple.

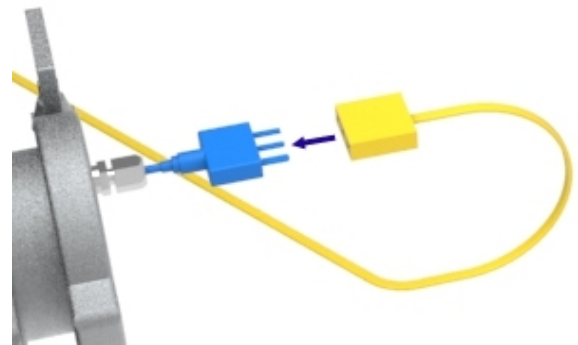

Note: To reduce the risk of tangling or damaging the thermocouple, always disconnect the lead before withdrawing the thermocouple from the furnace.

6.4 Inert Gas Package (Standard / Advanced)

The Carbolite Gero inert gas package flowmeter modules are designed to be used only with inert gases such as argon (Ar), nitrogen (N₂) and helium (He).

The modular system allows for up to three gas lines per furnace, which can be controlled either manually, or automatically via a solenoid valve linked to the furnace temperature controller.

Please refer to the separate Inert Gas Package manual for detailed installation and operation instructions.

6.5 Gas Safety System

The gas safety system is necessary when a combustible gas, such as hydrogen, is used within the furnace.

Please refer to the separate Laboratory Gas Safety System manual for detailed installation and operation instructions.

7.0 Installation

7.1 Manual Handling



Refer to the "Specifications" section of this manual for product weights and dimensions.



Mechanical lifting equipment may be necessary!

Consult personnel responsible for health and safety before attempting to move this product!

It is the responsibility of the customer to provide any mechanical lifting aids, such as pallet trucks, forklifts or cranes, and to ensure that all operators of such equipment are fully trained and qualified.



All manual handling must be carried out according to local health and safety guidelines.

7.1.1 Sling Guides

Attached to the underside of the furnace are two brackets. These brackets act as guides for any straps or slings placed under the furnace to assist with manual handling procedures.

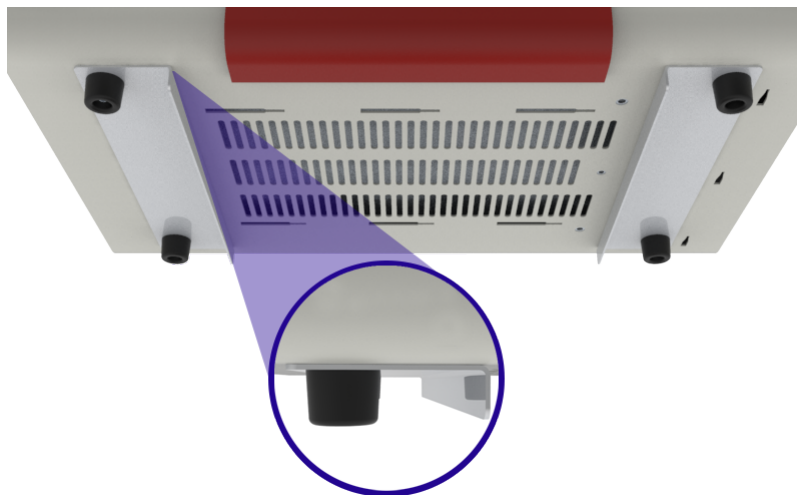

Note: The customer is responsible for all manual handling procedures performed on their own premises.

7.2 Unpacking

Note: Check that all items intended for delivery are present and undamaged before proceeding to install the product.

The product is delivered secured to a pallet for safety and manoeuvrability.

It is advised that the product is left on the pallet until it has been moved as close as possible to its intended installation location.

- If the furnace is intended to be mounted on a table or workbench, use appropriate lifting equipment to lift the pallet up to bench height.
- Ensuring that the product is stable and secure, remove any straps retaining the product to the pallet.
- Carefully slide the product off the pallet and onto the bench.

7.2.1 Vertical Orientation:

- If the furnace is ordered with the vertical package, it is delivered mounted on the vertical stand, but laid horizontally for transport.
- Once the furnace has been removed from the pallet, check the furnace is securely attached to the stand before proceeding.
- Securely attach a lifting strap to the top of the stand and use appropriate lifting equipment to carefully raise the furnace and stand to a vertical position.

7.3 Siting and Setting Up

The product should be sited in a well ventilated area, away from other sources of heat.



Note: If required, it is the customer's responsibility to provide an adequate extraction system. Under no circumstances should such an extraction system be connected directly to the product as this will affect product performance and may damage equipment.



Use the manual handling method recommended by your health and safety officer to place the product on a level, stable surface that is not prone to vibration or movement. The surface upon which the product is placed must be of a height suitable to allow the operator to easily and safely use the equipment.



The product should be placed on a non-flammable surface, resistant to the accidental spillage of hot materials. All adjacent surfaces should also be non-flammable.



Ensure that the power supply or isolating switch is easily accessible to the operator.



Note: If mounted on a vertical stand, the stand **MUST** be bolted down to the underlying surface. The customer is responsible for any injury or damage to equipment resulting from failure to comply with this instruction.

Note: Unless otherwise stated elsewhere in this manual, ensure that there is **at least 150 mm** of free space around the all sides of the product. Clear space is required above the product to dissipate heat.

Work tubes:



It is recommended that the work tube has either insulation plugs or radiation shields fitted to minimise heat loss from both ends of the work tube. If the work tube has open ends, a significant amount of energy could be radiated from the ends of the work tube. Adjacent surfaces should always be made from a non-flammable material. Ensure that the ends of the work tube are positioned **at least 500 mm** away from any adjacent surface so that any energy radiated cannot heat an adjacent surface to a dangerous temperature.

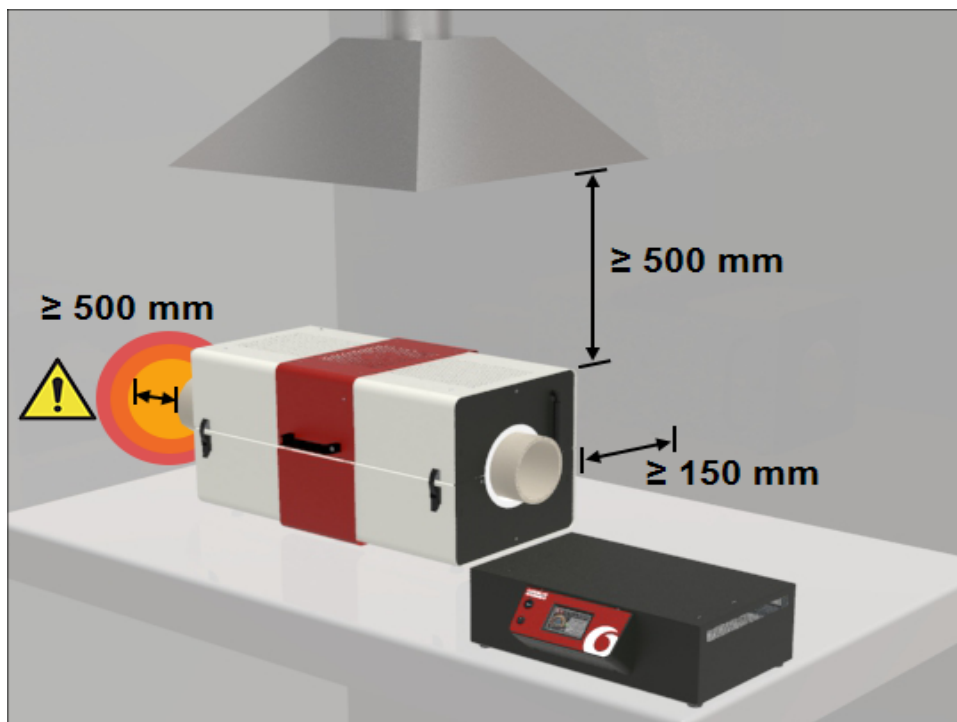

7.4 End Guard Installation

Where a work tube emerges from the furnace its surface and any adjacent metalwork can be too hot to safely touch. To prevent operators from accidentally touching these hot surfaces, end guards are available and included with all Carbolite Gero work tube packages that require an extended work tube.

The end guards may need to be removed and refitted in order to facilitate the installation of a work tube and associated accessories, such as tube supports and end seals.

To fit the end guards:

- Insert the hooks of the end guard into the slots at the end of the furnace end plate, and secure them with a single screw

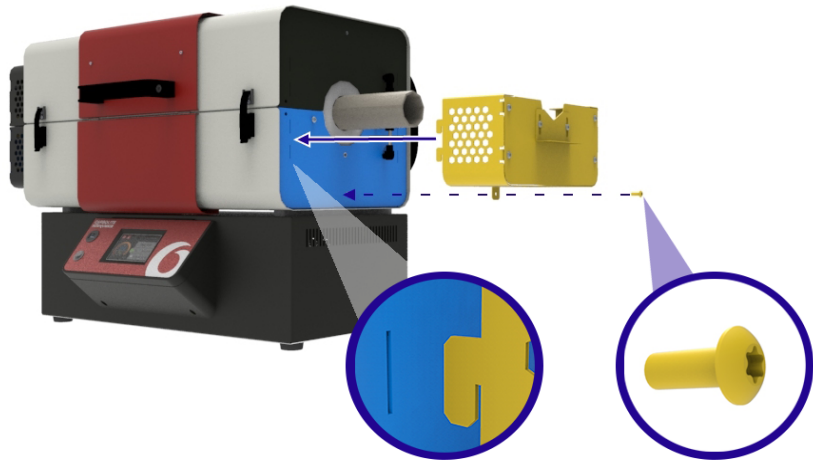

- Repeat this process for both the upper and lower halves at either side of the furnace

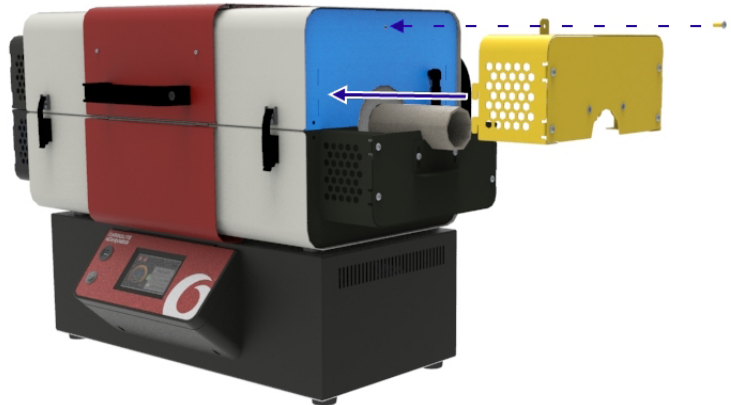

7.5 Work Tube Installation



Note: Disconnect the product from the electrical supply before carrying out any maintenance procedures.



Note: Do not operate the furnace without a work tube installed!



Note: If using a metal work tube it **MUST** be earthed!



Work tubes are fragile pieces of equipment. Depending on the size of the work tube, it may be advisable for more than one person to assist in its installation. Please consult your designated health and safety personnel for advice.



To avoid contamination, always wear clean gloves when handling the work tube.

Note: For ease of installation, it is recommended that work tubes are inserted when the furnace is orientated horizontally.

Note: The following images depict the fitting of an extended work tube, used when working with modified atmospheres. End guards are supplied only when the extended work tube package is ordered.

To install the work tube:

- Open the tube furnace and carefully insert the work tube into the furnace so that it rests on the insulation.
- Adjust the positioning of the work tube until an equal length of tube protrudes from each side of the furnace.

Note: If using an extended work tube, it is advised that the tube supports are adjusted accordingly (see section 7.8).



7.6 Lid Prop

For additional safety whilst performing maintenance procedures that require the removal of the pneumatic struts, this product is supplied with a specially designed lid prop.

The lid prop is fixed to the inside of the control box back panel.



Note: Disconnect the product from the electrical supply before carrying out any maintenance procedures.

To retrieve the lid prop:

- Locate the electrical component access panel at the rear of the control box.
- Remove all screws securing the panel to the control box.

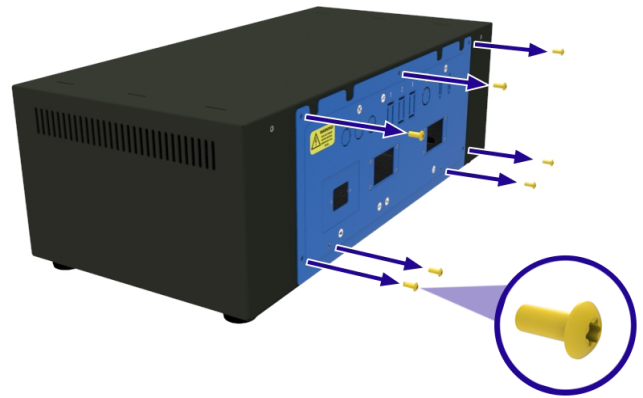

- Carefully slide the panel out of the control box, and disconnect the earth connection, taking care not to disconnect or damage any wiring.

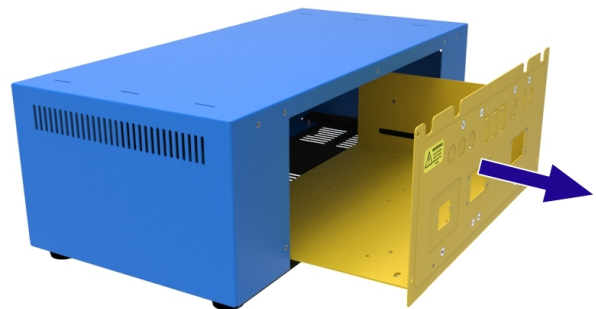

- Remove the two screws securing the lid prop to the electrical component access panel. Hold the lid prop whilst removing the screws to ensure that it does not fall onto and damage electrical components.
- Remove the lid prop from the control box and refit the electrical component access panel.

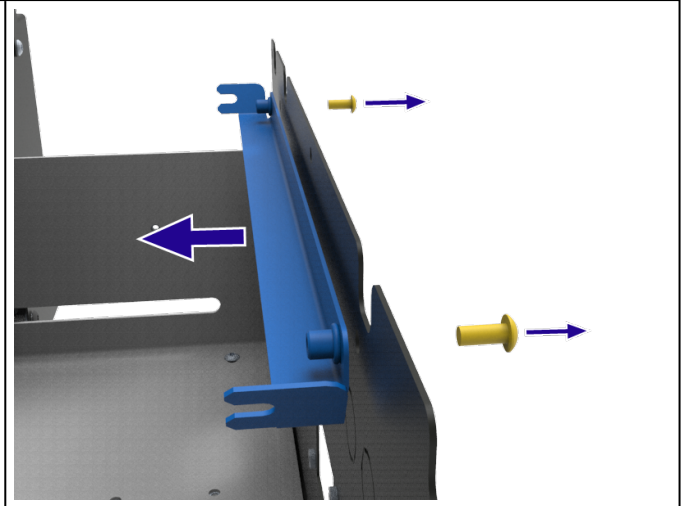

To securely insert the lid prop:

- Open the furnace.
- On the near right-hand side of the upper and lower insulation assemblies, carefully loosen the screws holding the insulation assemblies in place.

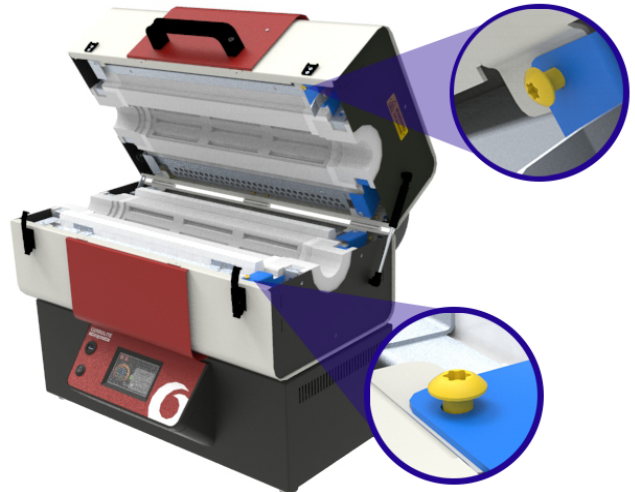

- Hook the end of the lid prop underneath the head of the screws and retighten them to secure the prop in place.
- Check the prop is secure before removing any pneumatic struts or proceeding with any maintenance tasks.

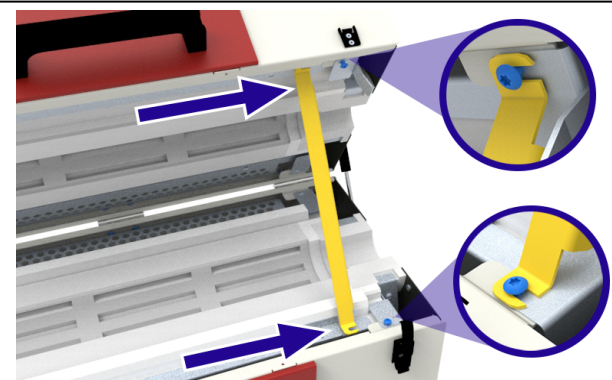

7.7 Insulation Collar Replacement



Note: Disconnect the product from the electrical supply before carrying out any maintenance procedures.



Note: This component is made from refractory ceramic fibre. Wear appropriate PPE.



Please refer to section 2.4 for more information

Note: Remove the work tube before proceeding with the following maintenance procedure.

Replacement insulation collars are supplied in sets of four. Each insulation collar is identical so can be fitted at any appropriate position within the furnace.

To replace the insulation collars:

- If fitted, remove the furnace end guards (see section 7.4).
- Open the furnace and insert the lid prop (see section 7.6).

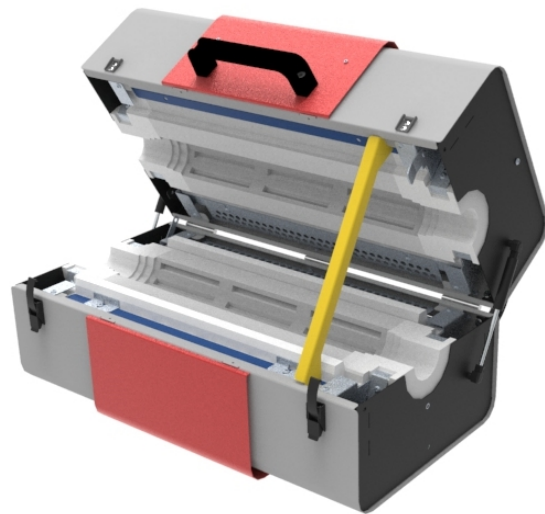

- Remove the pneumatic strut (see section 7.9).
- Disconnect the door switch assembly by removing the screws holding the two halves of the mechanism together.

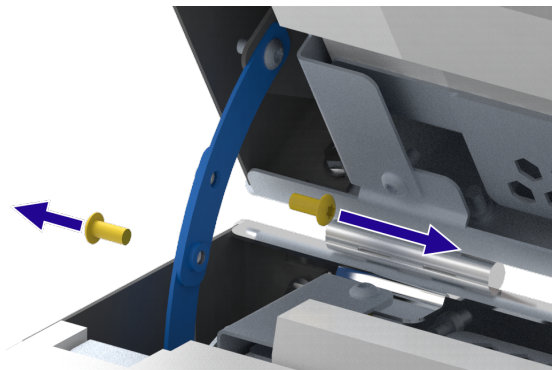

- Using a flexible 8mm hexagon nut driver, loosen the M5 flange nuts holding the furnace end plate in place.

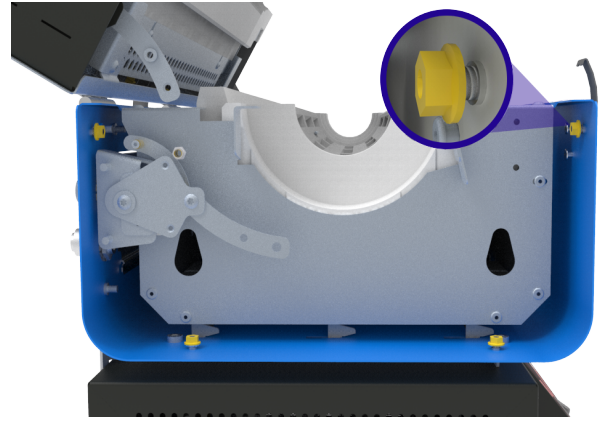

- Gently slide the end plate away from the furnace to provide an accessible gap.

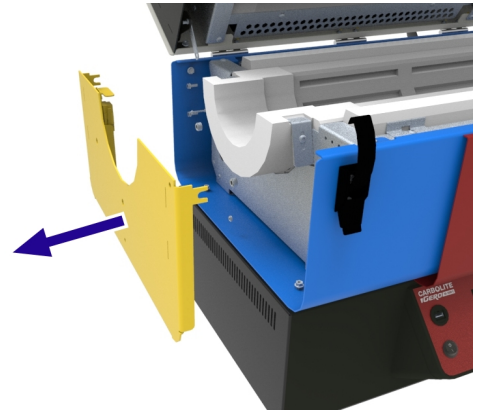

- Remove the M5 screw securing the insulation collar bracket in position.

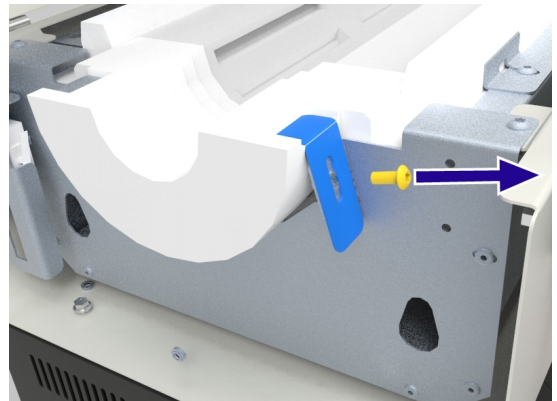

- Remove the bracket.

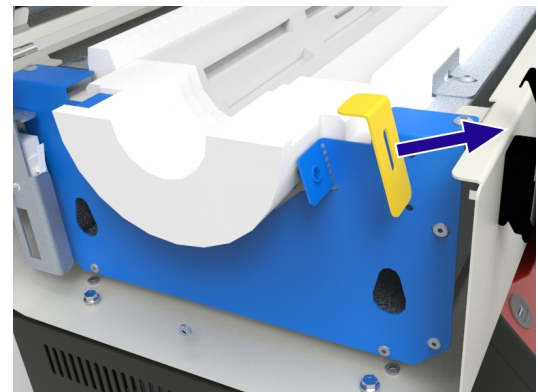

- Carefully rotate and lift the old insulation collar out of position.

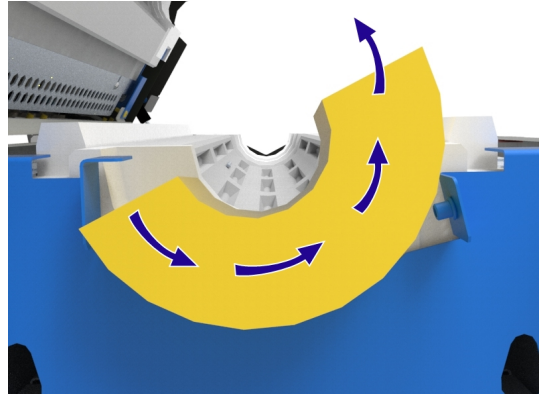

- Carefully insert the new insulation collar, ensuring that the groove on the flat face of the collar fits under the fixed bracket.

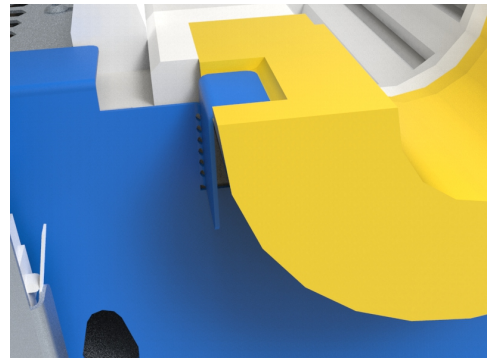

- Refit the insulation collar bracket and tighten it securely onto the groove on the insulation collar. You may need to apply some pressure to the bracket as you tighten the screw to ensure a suitably secure grip.

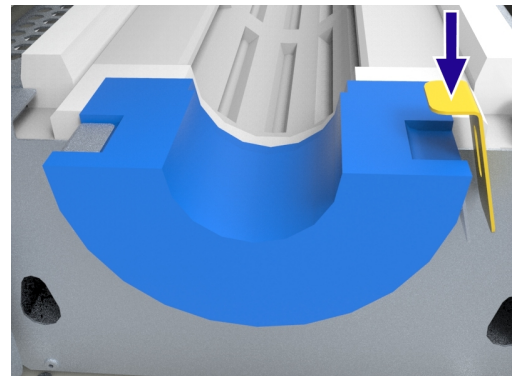

- Push the furnace end plate firmly back into position so that it presses against the insulation collar.

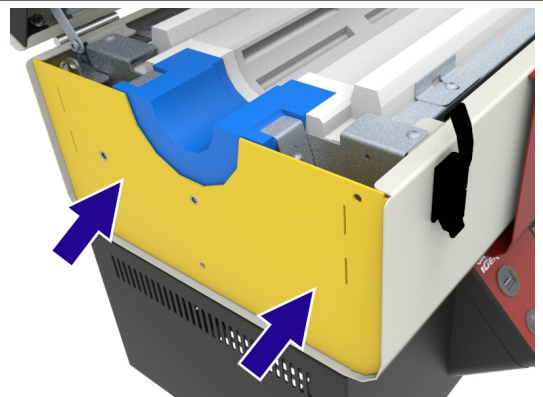

- Secure the end plate by tightening the flange nuts to 4Nm (Newton Metres of torque).

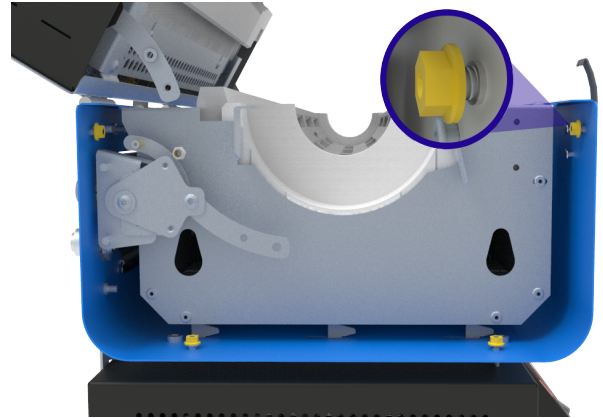

- Reconnect the door switch assembly by replacing the two screws connecting the mechanism.

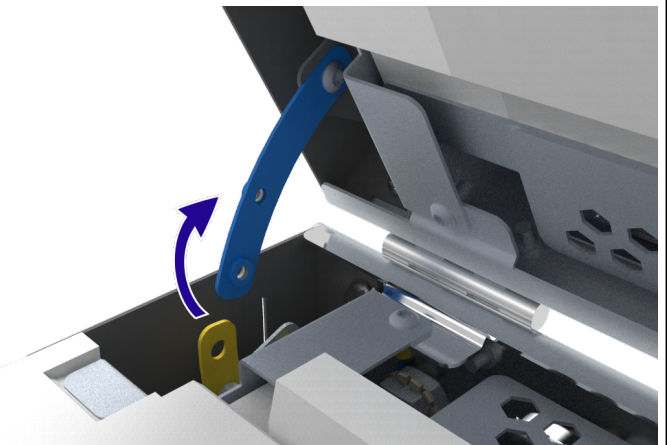

- Refit the pneumatic struts, then remove the lid prop and close the furnace.
- Check that the insulation collars are properly aligned before recommissioning the furnace.

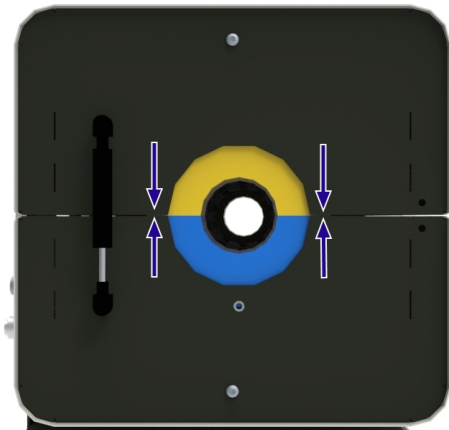

7.8 Work Tube Supports



Note: When heated to high temperatures work tubes can become subject to significant thermal expansion both in terms of length and diameter. Care must be taken to ensure that all additional supports accommodate for these changes in shape.



Note: Before adjusting the tube supports, fit the work tube according to the instructions given in section 7.5



Note: The customer is responsible for all external fittings and equipment not provided by Carbolite Gero. If external fittings are to be attached to the work tube end seals, ensure that they will not prevent the work tube from expanding and contracting due to changes in temperature. Obstructions can cause damage to the furnace, work tube and other equipment.

7.8.1 Horizontal Orientation

When the furnace is orientated horizontally, a standard work tube can be supported by the furnace insulation, however extended work tubes require additional support when fitted with end seals. Extended work tubes are typically used when working with modified atmospheres, such as gas or vacuum.

The horizontal support bracket is fixed to the lower half of the furnace end guard.

To adjust the positioning of the bracket:

- With the furnace closed, loosen the two screws holding the tube support bracket in place.
- Push the tube support bracket up so that it gently makes contact with the work tube, then retighten the screws to secure the plate in position.
- Repeat this process at the other side of the furnace.

Note: At high temperatures, the work tube will expand both in terms of length and diameter. To avoid additional stress on the work tube during this process, the work tube must be a loose fit. If gripped too tightly, the work tube is at a higher risk of breaking.

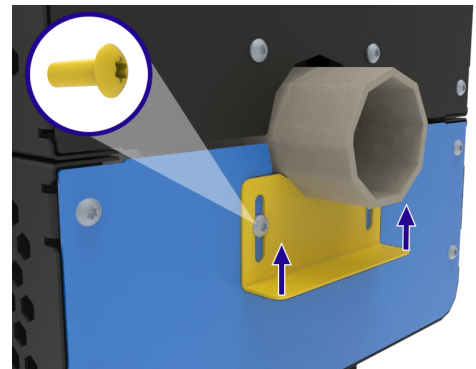

7.8.2 Vertical Orientation (Vertical Stand and Vertical Tube Support Package Only)

A support is required to prevent the work tube from sliding through the furnace. The support clamp assembly is attached to the bottom end of the furnace to prevent any

hot parts or fragments from dropping if the work tube breaks during use.

To allow for thermal expansion, the top of work tube is not gripped in place, but guided by an additional metal bracket at the top of the furnace. This reduces the mechanical stress upon the structure of the work tube.

Note: If the furnace was ordered specifically for vertical use, it will be supplied with the tube supports already fitted.

Note: The furnace is supplied with two separate support clamp assemblies to enable the use of work tubes across the full range of nominal outside diameters, 46-125mm. The smaller clamps are recommended for work tubes with outside diameters below 65mm.

To fit the vertical tube supports:

Note: For ease, it is recommended that the furnace is orientated horizontally when fitting the work tube.

- If fitted, remove the furnace end guards.
- The support clamp assembly should be attached to the end of the furnace that will become the bottom when it is orientated vertically.

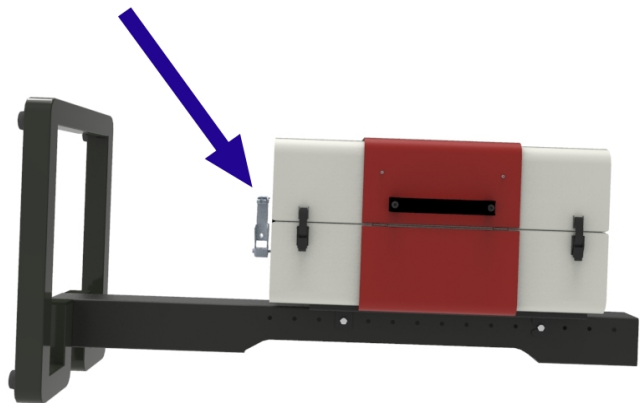

Note: For larger work tube diameters, the support clamp assembly has an additional adjustment bar situated below the work tube.

- Remove the adjustment bar(s) and securing nut(s) so that the support clamp opens wider than the outer diameter of the intended work tube.

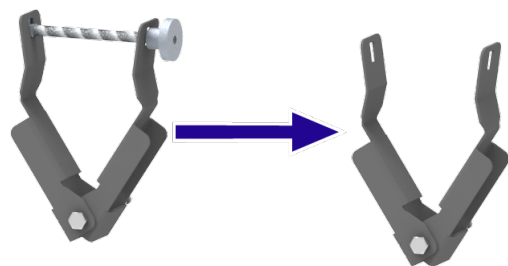

- Screw the support clamp assembly to the furnace end plate on the lower half of the furnace using the M6 bolt, and secure it in position by tightening the lock-nutnut.

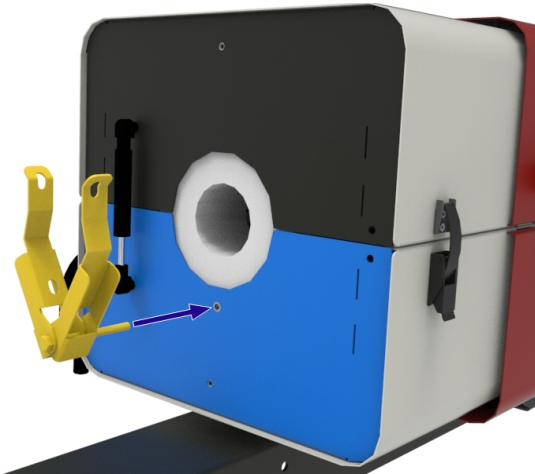

- Insert the work tube into the furnace (refer to section 7.5), carefully sliding one end through the support clamp assembly so as not to damage the tube.

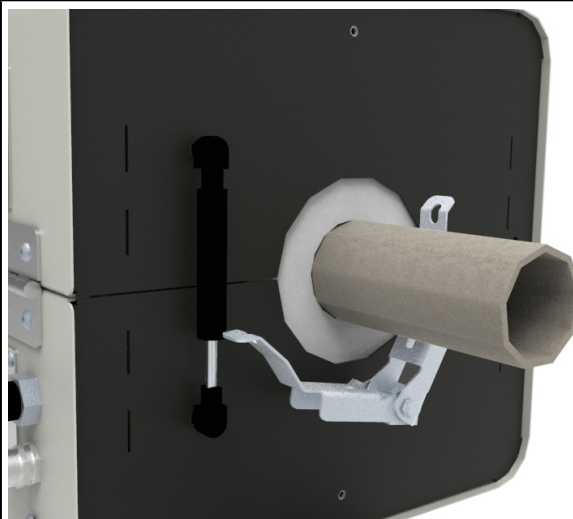

- Refit the adjustment bar(s) and securing nuts, then gently tighten the support clamp assembly until it securely grips the work tube.

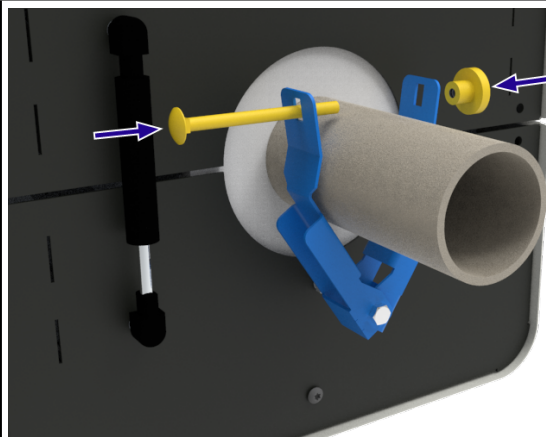

- At the other end of the furnace, attach the U-shaped metal guiding bracket to the lower end plate with two M5 screws. These screws can be loosened so that the positioning of the bracket can be adjusted once the work tube is fitted.

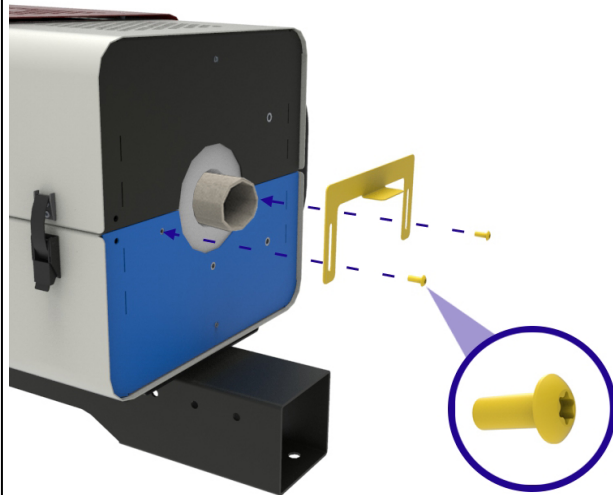

- Adjust the positioning of the guiding bracket until it is close to the work tube, but not gripping it, then tighten the screws to secure it in position. The loose fit will help allow for thermal expansion of the work tube.
- Once the work tube is safely secured in place, refit the furnace end guards.

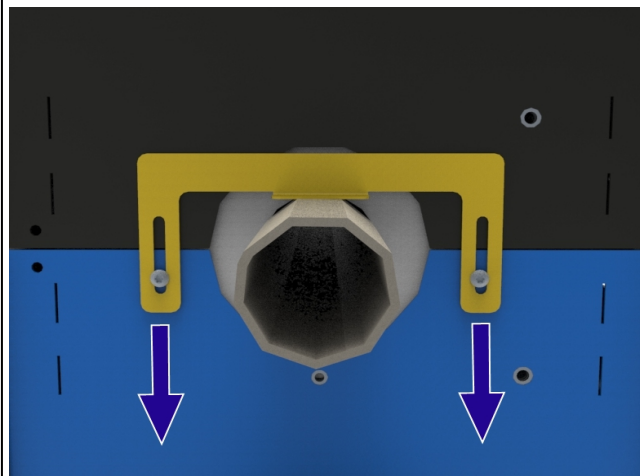

7.9 Pneumatic Strut Replacement

To support the lid of the furnace when opened, a pneumatic strut is fitted at either end of the furnace to limit the opening angle to 60°.

To replace the pneumatic struts:

- Remove the furnace end guards (if fitted).
- Open the tube furnace and insert the lid prop to support the upper half.
- Using a small flat-headed screwdriver, gently prise away the small metal clips at the ends of the pneumatic struts, ensuring that the clip is not fully detached from the joint.

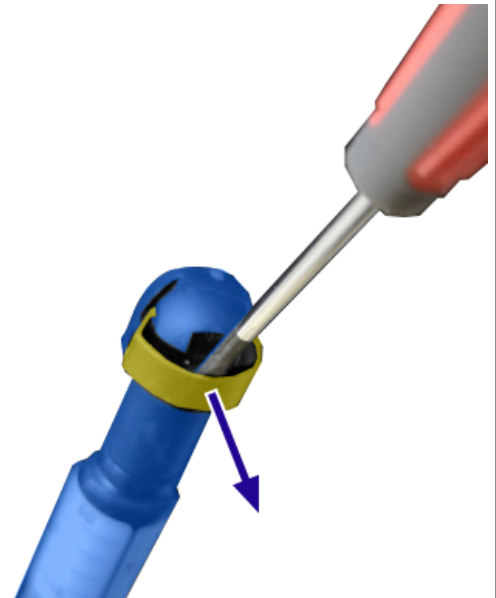

- Carefully pull the pneumatic strut away from the furnace end plate
- Check that the ball joint connecting the pneumatic strut to the furnace end plate is sufficiently lubricated.
- Push the replacement pneumatic strut into position, ensuring that the strut is of the same force rating (N) as the one that was removed. Check the label on top end of the strut.
- Refit the furnace end guards.



7.10 Mounting the Furnace on the Vertical Stand



Note: Disconnect the product from the electrical supply before carrying out any maintenance procedures.

The vertical stand is only included as part of the "Vertical Stand and Vertical Tube Support Package". Please contact Carbolite Gero for details.



Note: DO NOT attempt to move the product when it is hot. Wait until it has cooled down to room temperature.



Note: DO NOT attempt the following steps without assistance. Specialised lifting equipment is required to lift and move the product.

<ul style="list-style-type: none"> • Lay the vertical stand down horizontally. It may be necessary to support the top of the stand on a block / packer to ensure that it is completely level. 	
<ul style="list-style-type: none"> • On the underside of the furnace there are tapered slots that allow the furnace to be fixed to the mounting bracket • Using the appropriate lifting equipment (refer to the "Unpacking and Handling" section of this manual) lower the furnace down onto the mounting bracket, ensuring that all hooks are located securely into the tapered slots. 	

- Carefully push the furnace towards the base of the stand to ensure the hooks are securely engaged into the taper, and the end of the furnace body is flush against the return on the bottom of the mounting bracket.

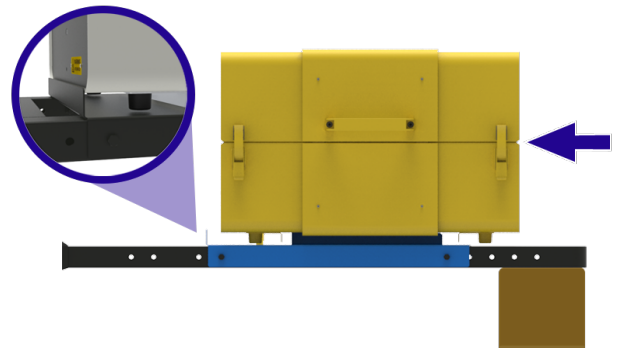

- Insert the security screws through the back of the mounting bracket and into the base of the furnace to lock it securely in place.

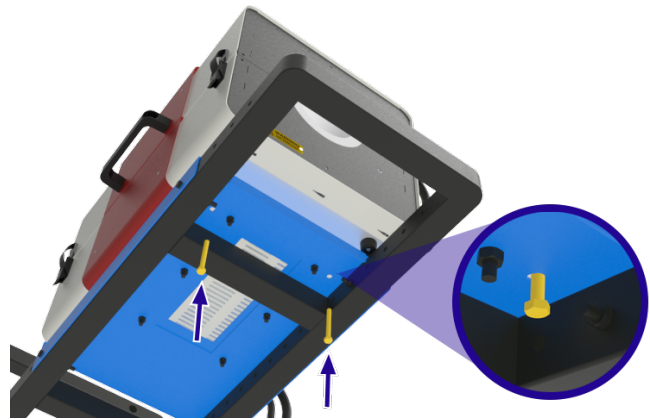

- Using the appropriate lifting equipment, raise the furnace stand into a vertical orientation.

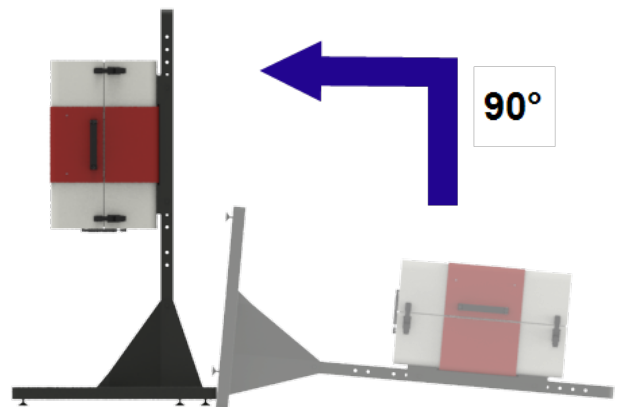

7.11 Securing Vertical Stands to a Surface



Note: The customer is responsible for ensuring that the surface to which the stand is to be mounted is suitable to support the weight of both the stand and furnace. The customer is also responsible for providing appropriate hex head fixings and washers for securing the stand to the intended mounting surface.



Note: DO NOT attempt the following steps without assistance. Specialised lifting equipment is required to lift and move the product.

7.11.1 Horizontal Surface

- Make four holes in the surface to which the furnace is to be mounted. The holes should be positioned according to the dimensions given in the accompanying diagram.

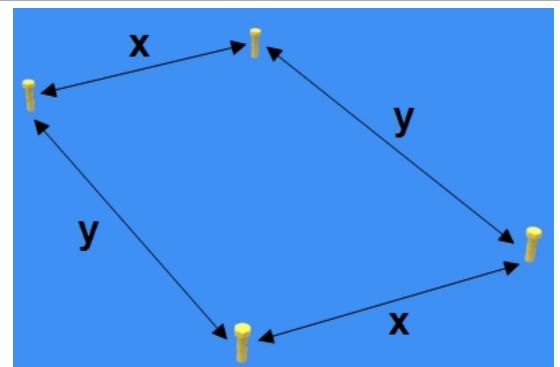

x	525mm
y	750mm

- The feet on the base of the stand can be adjusted to accommodate slightly uneven surfaces. It is possible to increase or decrease the height by loosening the nuts holding the feet in place, moving the feet to the desired position, then retightening the nuts. Ensure that the nuts are secure before uprighting the furnace and stand.

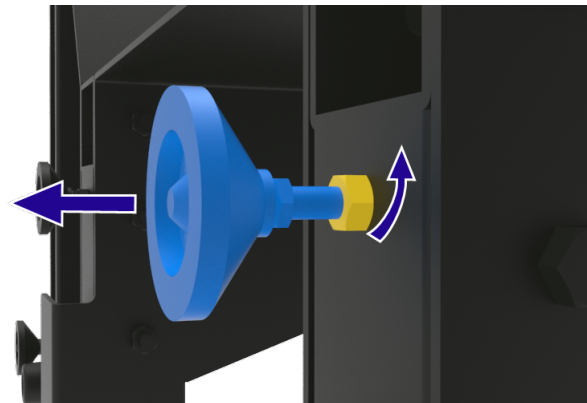

- Using the appropriate lifting equipment, vertically orientate the furnace and stand, positioning them so that the holes in the base of the stand align with the holes made in the surface.
- Feed four hex head fixings through the holes in the base of the stand. It is recommended that a washer is placed between the hole on the lower surface of the base, and the head of the fixing.
- Tighten the fixings so that the furnace and stand are attached securely to the surface and cannot be tipped over.

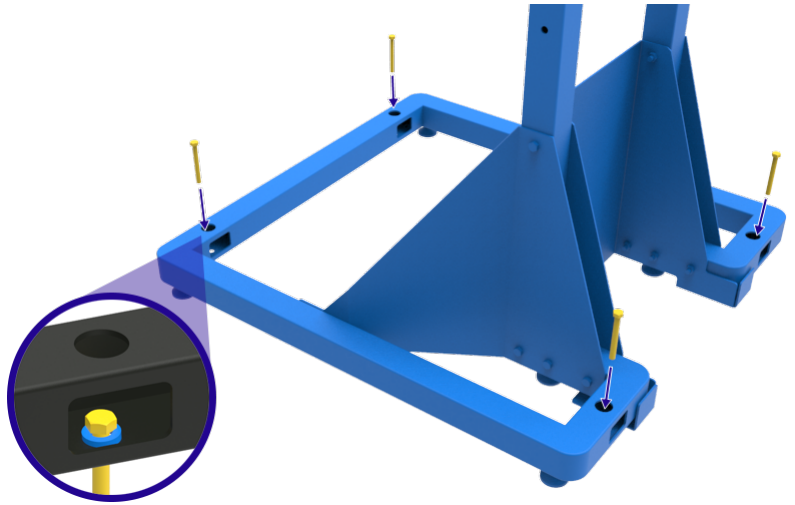

7.12 Electrical Connections



For products supplied without pre-fitted plugs, it is recommended that all electrical connections are carried out by a qualified electrician.

The product covered by this manual normally requires a single phase A.C. supply, which may be "Live to Neutral non-reversible", "Live to Neutral reversible" or "Live to Live". Some models may be ordered for 3-phase use, which may be with or without neutral.

Check the product rating label before connection. The supply voltage should correspond with the voltage on the label and the supply capacity should be sufficient for the current on the label.

The supply should be fused at the next size equal to, or higher than the current on the label. This manual contains a table of the most common fuse ratings.

- When the mains cable is factory-fitted / supplied, internal fuses are also fitted. It is essential that the operator ensures that the power supply is correctly fused.
- Products with a factory fitted supply cable but without a plug are designed to be wired directly to an isolator or fitted with a line plug compliant with the customer's local regulations and supply.
- Products without a factory-fitted supply cable require a permanent connection to a fused and isolated supply. The product's electrical component access panel should be temporarily removed, and connections made to the internal terminals / fuse holder.

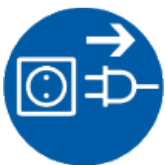

When connecting the product to the power supply, the plug or isolating switch should be accessible, easy to remove / operate, and within reach of the operator.

Note: The supply MUST incorporate an earth (ground).

7.12.1 1-Phase Connections

Terminal Label	Cable Colour	Supply Type & Connection	
		<i>Live - Neutral</i>	<i>Reversible or Live - Live</i>
L1	Brown	to live	to either power conductor (for USA 200-240 V, connect L1)
N / L2	Blue	to neutral	to the other power conductor (for USA 200-240 V, connect L2)
PE	Green / Yellow	to earth (ground)	to earth (ground)

7.12.2 3-Phase Connections

Terminal Label	Cable Colour	Connection
L1	Black	to phase 1
L2	Black	to phase 2
L3	Black	to phase 3
N	Light Blue	to neutral (if fitted)
PE	Green / Yellow	to earth (ground)

7.13 Mains Supply Cable

IEC	3-core, 1.5mm ² rated to 16 Amp, 250 VAC
------------	---

7.14 Connecting a Supply Cable to Internal Terminals



For products rated above 16 Amps supplied without pre-fitted plugs, all electrical connections should be carried out by a qualified electrician.

- Locate the electrical component access panel at the rear of the control box.
- Remove all screws securing the panel to the control box.

- Carefully slide the panel out of the control box, and disconnect the earth connection, taking care not to disconnect or damage any wiring.

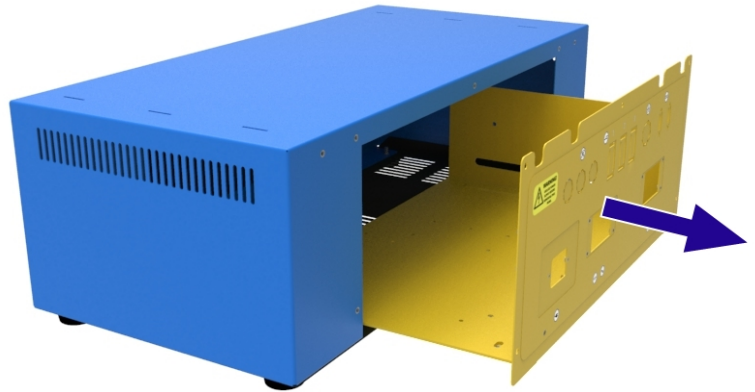

- On the electrical component access panel, fit an appropriate sized gland for the cable required.
- To connect the Live and Neutral wires (e.g. L1, N/L2), loosen the screw on the top of the fuse holder and fully insert the wire into the slot. Tighten the screw to secure the wire in place.
- To connect the earth (PE) wire, insert an appropriately sized flat blade screwdriver into the slot on the top of the terminal and fully insert the wire into the round hole. Remove the screwdriver to secure the wire in place.

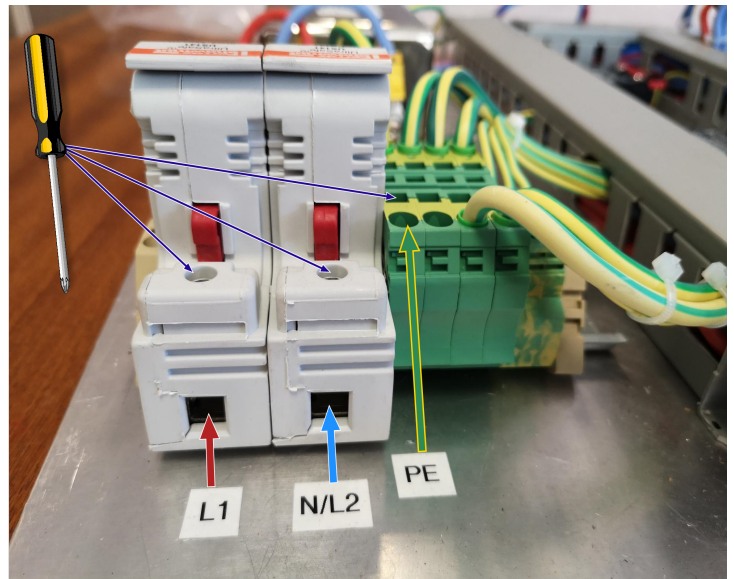

Note: The number of Live terminals will differ depending on the product and power supply configuration ordered.

8.0 Commissioning

Note: This equipment should not be put into use until it has been commissioned by a competent person in accordance with the instructions contained within this manual, and any local regulations. Carbolite Gero offer an installation and commissioning service. Please contact Carbolite Gero Service for details.

8.1 Pre-Commissioning

When the product is cold and disconnected from the power supply, visually check the following:		Checked by:
Siting / Securing	Check that the product is placed on a secure, level surface and cannot topple over when both open and closed. If mounted vertically, ensure the stand is bolted to the floor or work surface before use.	
Packaging	Check that all packaging material has been removed from inside and around the product.	
General Condition	Check that no damage has occurred during delivery and siting.	
General Access	Check that there is sufficient clearance around the top and all sides of the product when both open and closed. Refer to the "Installation" section of this manual for required clearance dimensions.	
Ventilation	Check that the product has been installed in a well ventilated area.	
Extraction	If a room extraction system is in operation (not supplied by Carbolite Gero), check that there is sufficient clearance between the extraction hood and the product. Refer to the "Installation" section of this manual for required clearance dimensions.	
Thermal Insulation	Check for signs of damage, deterioration, excessive cracking or missing insulation material. (Please refer to section 10.4)	
Safety Guards and Panels	Check that all covers, safety guards (if ordered) and access panels are securely fitted.	
Door Operation	Check that the door / top of the furnace has not become misaligned during transit. Check that the furnace opens easily and that all hinges, pneumatic struts and latches are operating as intended.	

	The furnace should not immediately fall shut when the operator releases the handles.	
Electrical Supply	Check that the voltage stated on the product rating label matches the electrical supply of the installation site. If a mains cable has been provided, check that it is securely attached to/ plugged into the product. If the product is rated above 16 Amps and requires a separate mains cable to be wired directly into the product, check that the cable is rated correctly and fitted by a qualified electrician.	
Earth Connection	Check that an earth connection has been made. All removable panels should be earthed.	
Gas Connections / System (if fitted)	If the product was ordered with ancillary equipment for working with gases e.g. inert gas package, gas safety system etc. check that all connections have been made as detailed in this manual.	
Rating Label / Warning Labels	Check that all labels are fitted and all information is legible. (See section 3.2)	

8.2 Commissioning - Initial Function Checks



Note: Do not operate the furnace without first installing a work tube. Operating without a work tube exposes the operator to live electrical components (heating elements) and subsequent risk of electric shock.

When the product has been connected to the mains electrical supply, check the following:		Checked by:
Instrument Switch	Check that when turned to the ON position, the temperature controller(s) illuminates.	
Main Temperature Controller	Check that the temperature controller is functioning correctly by setting a setpoint or starting a program as instructed in the controller manual instructions. The product should begin to heat to the set / programmed temperature. The furnace is despatched with all controller setpoints set to 0°C to ensure that the product does not unintentionally start heating during initial commissioning checks.	
Safety Switch	While it is heating and the temperature is below 200°C, open the furnace and check that the power to the heating elements cuts off. The heater lamps at the rear of the control box should stop illuminating. The product should stop heating if the safety switch is functioning correctly.	

	<p>Note: DO NOT open the furnace at high temperatures. Doing so may cause the work tube to shatter.</p>	
Over-Temperature Controller (if fitted)	Set the over-temperature setpoint lower than the temperature displayed on the main temperature controller. The over-temperature should go into an alarm state and the product should stop heating.	
Gas connections / system (if fitted)	<p>Note: Please refer to the separate Inert Gas Package / Laboratory Gas Safety System manual for details.</p> <ul style="list-style-type: none"> • Check that the supply pressure is regulated to a maximum of 0.2 bar (3 psi). • If an over-pressure valve is fitted ensure that it is directed away from both operators and sensitive equipment. • Check that all the connections to the gas supply are secure and that gas flows correctly through the system e.g. flowmeters register, any solenoid valves open. 	
Work tube	<ul style="list-style-type: none"> • Check that the work tube is fitted before operation. • Check that the work tube has room to expand/contract during heating. The work tube must be a loose fit inside the furnace. 	
Work tube package (optional)	<ul style="list-style-type: none"> • Check that the work tube is fitted before operation. • Check that the work tube has room to expand/contract during heating. The work tube must be a loose fit inside the furnace. • Check that the insulation plugs / radiation shields are fitted. • If end seals are required, check that they are securely fitted. • Check that the work tube supports are correctly fitted. 	

9.0 Temperature Controller

If this product is fitted with a temperature controller, instructions are provided separately.

10.0 Operation

10.1 Operating Cycle



Note: The customer is responsible for conducting their own risk assessment prior to operating this product.



Note: Ensure that all pre-commissioning and commissioning checks have been performed before proceeding with normal operation of this product. Please refer to section 8.0 for a list of recommended checks.



Note: Always ensure that the operator is wearing the appropriate PPE when operating this product. Please consult your Health and Safety personnel and refer to section 2.0.

1. After installing all equipment and accessories as required, connect the product to the electrical supply.
2. Turn on the instrument switch to activate the temperature controllers. The controllers will illuminate and go through a short test cycle.
3. Set up the temperature controllers as required. Please refer to the separate temperature controller manual for details on controller operation.
4. If the product is fitted with over-temperature protection, set the required over-temperature setpoint according to the instructions detailed in the separate controller manual.
5. If a setpoint has been set on the main controller, either manually or via a program, the product will begin to heat up.
6. Diagnostic heater lamps at the rear of the control box will illuminate when the product is heating.
7. Proceed with your heating process.
8. If the product is fitted with over-temperature protection and the over-temperature alarm is triggered, follow the instructions in the separate controller manual to reset and continue with your heating process.
9. To switch off power to the heating elements, reduce the setpoint to 0°C on the main temperature controller.
10. Switching off the instrument switch will cut power to the heating elements and temperature controller(s).

Note: If the product is to be left switched off and unattended, isolate it from the mains electrical supply.

10.2 Safe Operation



This product can be operated continuously up to **100°C below** the maximum operating temperature, however constant use at high temperatures can accelerate the degradation process of various components which will require replacement. Please contact Carbolite Gero to request the "Maintenance" manual for your product.



Note: DO NOT leave the product operating unattended unless the over-temperature protection option is fitted.



Refer to the "Safety" section of this manual for details on ensuring operator safety.

Explosive materials:



- The furnace must not be used to heat materials that could explode, or that could emit gases that could form explosive mixtures. If the safe heating of a material is dependent on its temperature, only heat these types of materials if the furnace has the optional over-temperature protection device fitted.
- Ensure that the over-temperature device is calibrated and set to an over-temperature safety limit that is appropriate for the material being heated so as to avoid any hazards. If in doubt, seek expert advice before proceeding.
- Customers are responsible for carrying out their own risk assessments on the heating of materials.

Do not operate without a work tube/vessel:



- The furnace must not be operated without the correctly sized work tube and corresponding work tube adaptors.
- If operated without a work tube, it may be possible for an operator to access electrically live heating element coils, which could cause serious injury or death.

Switch off the furnace before loading and unloading:



- The furnace elements must be switched off using the instrument switch when the furnace is being loaded or unloaded.
- The work tube can become electrically conductive at high temperatures. If an element has failed and collapsed onto the work tube, the work tube will become live which could cause serious injury or death.

10.3 Recommendations for Work Tube Usage

10.3.1 Inserting Work Pieces and Samples

- Great care should be taken if inserting cold pieces into a hot work tube as the difference in temperature can cause thermal stresses, which may subsequently break the work tube. To avoid this, it is recommended that cold pieces are inserted into the work tube at ambient temperature prior to heating.
- Large work pieces should be heated slowly to ensure that large temperature differences do not arise.
- Ensure minimal surface contact between the work piece and the tube to reduce thermal conduction between the two; crucibles or boats should be of low thermal mass.

10.3.2 Running at High Temperatures

- During heating, the work tube will increase in both length and diameter, a process known as thermal expansion. The rate of thermal expansion is dependent on the properties of the work tube material and the temperatures to which it is exposed.
- Unsupported sections of the work tube may experience some drooping malformations when hot, which can stress the material and increase the risk of breakage.
- If running the furnace at high temperatures, it is recommended that the work tube is rotated 180° after the completion of each run to equalise the amount of stress on each side of the work tube.

10.3.3 Heating Rates

Note: Do not set too high a heating or cooling rate, as tubes are susceptible to thermal shock and may break. Tubes which extend beyond the heated part of the furnace are more at risk.

- A general rule for maximum heating or cooling rate is $400 \div$ internal diameter in mm to give (°C/ min); for tubes with an inner diameter of 75 mm, this is an increase of 5 °C per minute.
- The controller can be set to limit both the heating and cooling rate.

10.4 Insulation Cracking

In these furnaces the insulation material is susceptible to surface cracking as a result of high temperature cycling; this is a normal occurrence and such cracking is not detrimental to the performance of the furnace.

10.5 Pressure



Work tubes are not intended to accept high internal pressure. When gas seals or similar fittings are in use, the gas pressure should be restricted to a **maximum of 0.2 bar (3 psi)**. A pressure of approximately half of that should normally be sufficient to achieve the desired flow rate. The operator must ensure that the exhaust path from the tube is not blocked, so that excess pressure does not occur.

- A suitably regulated gas supply should always be used.
- It is recommended that a pressure relief system should be used to avoid an over pressurisation of the work tube.

Note: A product should not be heated up if any valves that have been fitted are closed to create a sealed volume. A sealed work tube should not be heated from cold due to the pressure increase caused by the trapped air or gas expanding during the heating process.

11.0 Maintenance

11.1 General Maintenance

Preventive rather than reactive maintenance is recommended. The type and frequency depends on the product use; the following are recommended.













11.2 Maintenance Schedule

 CUSTOMER

 QUALIFIED PERSONNEL



DANGER! ELECTRIC SHOCK. Risk of fatal injury. Only electrically qualified personnel should attempt these maintenance procedures.

Maintenance Procedure	Method	Frequency				
		Daily	Weekly	Monthly	Bi-Annually	Annually
Safety						
Over-Temperature Safety Circuit (if fitted)	Set an over-temperature setpoint lower than the displayed temperature and check for an over-temperature alarm as detailed in this manual					
Over-Temperature Safety Circuit (if fitted)	Electrical measurement 					
Safety Switch Function (split models only)	Set a temperature above ambient (no higher than 200°C), and open the furnace to see if the heater light goes out					
Safety Switch Function (split models only)	Electrical measurement 					
Electrical Safety (external)	Visual check of external cables and plugs					
Electrical Safety (internal)	Physically check all connections are tight, with no visible evidence of heat damage before proceeding with cleaning of the power plate area					
Electrical Safety (earthing)	Using a megohmmeter (insulation resistance tester), check the earth connection between the cable entry point and the main earth connection point, then between the main earth connection and the power plate, control box screw heads, top and bottom of the furnace body and vertical stand (if in use)					
Function						
Temperature Calibration	Tested using certified equipment, frequency dependent on the standard					

	required						
Operational Check	Check that all functions are working normally						
Operational Check	Thorough inspection and report incorporating a test of all functions						6
Work Tube Position	Visually check that the tube is central to the heated zone (horizontally / vertically)						
End Plugs / Radiation Shields	Visual check for damage or wear, and correct positioning						
Seals (if fitted)	Check all seals and O-rings and clamps						
Pneumatic struts	Ensure that the lid of the furnace is fully supported by the pneumatic struts when the furnace is opened.						6
Performance							
Element Circuit	Electrical measurement 						6
Power Consumption	Measure the current drawn on each phase / circuit						6
Cooling Fans (if fitted)	Check whether the cooling fans are working						

11.3 Cleaning



Note: Disconnect the product from the electrical supply before carrying out any maintenance procedures.

- With the product switched off, cold, and electrically isolated from the mains, wipe over surfaces using a damp cloth, wrung almost dry.
- **DO NOT** use solvents.
- If necessary, vacuum out the inside of the product to remove any dust or minor debris and dispose of any material removed, in accordance with local regulations, at an approved disposal facility.



Note: Care must be taken to ensure that no moisture enters the furnace or makes contact with any electrical components.

11.4 Safety Switch

When correctly functioning, the safety switch will isolate all live conductors (live and neutral connections) within the heating element circuit(s) when the product door is opened. The safety switch should be checked regularly to ensure that this occurs.

The safety switch should not fail under normal working conditions, however rough handling, exposure to corrosive materials/ environments, or exceptionally frequent use, could compromise the safety system.

Weekly check:

The following check can be carried out by a general operator:

- On the temperature controller, set a safe temperature above ambient. The heater lights should illuminate.
- Open the door and check the heater lights. They should no longer be illuminated.

If the heater lights remain illuminated when the door is open, discontinue use and contact Carbolite Gero Service.

Annual check:

The following checks should be carried out by a qualified electrician, as specified in the "Maintenance Schedule" section of this manual:

- Remove the element access panel and take a voltage measurement from the heating element terminals. Do not attempt to take a reading from the heating element itself as surface oxidation will give an unreliable contact.
- Ensure that power to the heating elements is switched off when the door is opened.

Contact Carbolite Gero Service and discontinue use of the product if it is found that the heating elements are not fully isolated during these checks.

11.5 Calibration

After prolonged use, the controller and/or thermocouple may require recalibration. This is important for processes that require accurate temperature readings or for those that use the product close to its maximum temperature. A quick check using an independent thermocouple and temperature indicator should be made from time to time to determine whether full calibration is required. Carbolite Gero can supply these items.

Depending on the controller fitted, the controller instructions may contain calibration instructions.

11.6 After-Sales Service

Carbolite Gero Service has a team of Service Engineers who can offer repair, calibration and preventive maintenance of furnace and oven products both at the Carbolite Gero factory and at customers' premises throughout the world. A telephone call or email often enables a fault to be diagnosed and the necessary parts to be despatched.

In all correspondence please quote the serial number and model type given on the rating label of the product. The serial number and model type are also given on the back of this manual when supplied with the product.

Carbolite Gero Service and Carbolite Gero contact information can be found on the back page of this manual.

11.7 Recommended Spare Parts and Spare Parts Kit

Carbolite Gero can supply individual spare parts or a kit of the items most likely to be required. Ordering a kit in advance can save time in the event of a breakdown.

Please consult Carbolite Gero's Sales Department for details of recommended spare parts.

11.8 Maintenance Manual

Instructions for the repair and replacement of common components are detailed in the separate "Maintenance Manual" for this product. Please contact Carbolite Gero to request a copy.

12.0 Fault Analysis

Note: The heating lamps are located at the rear of the control box.

A. Furnace Does Not Heat Up

1.	The heating lamps are ON	▶	The heating element has failed	▶	Check also that the SSR is working correctly
2.	The heating lamps are OFF	▶	The controller shows a very high temperature or code such as S.br (Sensorbreak)	▶	The thermocouple has broken or has a wiring fault
		▶	The controller shows a low temperature	▶	The door switch(es) (if fitted) may be faulty or need adjustment
				▶	The contactor/relay (if fitted) may be faulty
				▶	The SSR could be failing to switch on due to internal failure, faulty logic wiring from the controller, or faulty controller
		▶	There are no lights glowing on the controller	▶	Check the supply fuses and any fuses in the furnace control compartment
				▶	The controller may be faulty or not receiving a supply due to a faulty switch or a wiring fault.

B. Product Overheats

1.	Product only heats up when the instrument switch is ON	▶	The controller shows a very high temperature	▶	The controller is faulty
		▶	The controller shows a low temperature	▶	The thermocouple may be faulty or may have been removed out of the heating chamber
				▶	The thermocouple may be connected the wrong way around
				▶	The controller may be faulty
2.	Product heats up when the instrument switch is OFF	▶	The SSR has failed "ON"	▶	Check for an accidental wiring fault that could have overloaded the SSR

13.0 Decommissioning, Storage and Disposal

13.1 Decommissioning

1. Reduce the setpoint on all temperature controllers to 0°C so that heating cannot begin accidentally when the product is recommissioned
2. Isolate the product from the power supply
3. Allow the product to cool to room temperature
4. Disconnect the product from the power supply
5. Disconnect all additional equipment and external connections e.g. gas supplies
6. Remove and store the work tube

13.2 Storage (Long Term)

Store in a cool, dry place.



Note: If the furnace is exposed to a humid environment during storage, it must be fully dried out before recommissioning. All internal electrical circuits should be checked for signs of moisture. If there are visible signs of moisture, the product should be isolated from the power supply and allowed to dry out at ambient temperature for at least 24 hours. Please contact Carbolite Gero Service for further advice.

13.3 Disposal



Note: This product should only be disposed of in accordance with local regulations and requirements regarding electrical equipment.

Within the European Community the disposal of electrically operated devices is regulated according to guidance based on the EU Directive 2012/19/EU on Waste Electrical and Electronic Equipment (WEEE). Disposal regulations may differ worldwide.

If uncertain, please contact Carbolite Gero for advice on disposal.

14.0 Declaration of Conformity



UK CA	Declaration of Conformity In accordance with BSEN ISO/IEC 17050-1 Certificate No: 001	CE
Manufacturer's Address:	CARBOLITE GERO Ltd, Parsons Lane, Hope, Hope Valley, S33 6RB, England, UK. info@carbolite-gero.com www.carbolite-gero.com	
Product Range:	TS1 / TS3 – Split Tube Furnaces	
Models:	12/60/150, 12/60/300, 12/60/450, 12/60/600, 12/125/400, 12/125/600, 12/125/800, 12/125/1000, 12/125/1200, 12/125/600, 12/200/1200	
Carbolite Gero Ltd hereby declare that the products specified above comply with the essential safety requirements of the:		
Low Voltage Directive:	2006/95/EC (and its amending directive 2014/35/EU) in accordance with the standards:	
BS EN 61010-1-010:2010	Safety requirements for electrical equipment for measurement, control, and laboratory use. General requirements.	
BS EN 61010-2-010:2014	Safety requirements for electrical equipment for measurement, control and laboratory use. Particular requirements for laboratory equipment for the heating of materials.	
EMC Directive:	2004/108/EC (and its amending directives) in accordance with:	
BS EN 61326-1	Electrical equipment for measurement, control and laboratory use. EMC requirements. General requirements. Class "A" Equipment "suitable for use in all environments other than domestic and those directly connected to a low voltage power supply network which supplies buildings used for domestic purposes". Table 2 – "Immunity test requirements for equipment intended to be used in an industrial environment".	
BS EN 55011	Industrial, scientific and medical equipment. Radio-frequency disturbance characteristics. Limits and methods of measurement	
RoHS2 Directive:	2011/65/EU On the restriction of the use of certain hazardous substances in electrical and electronic equipment.	
Category #9	Monitoring and control instruments including industrial monitoring and control instruments.	

Signed:  Quality Manager

Date: 4/6/20

ProductLabel

The products covered in this manual are only a small part of the wide range of ovens, chamber furnaces and tube furnaces manufactured by Carbolite Gero for laboratory and industrial use. For further details of our standard or custom built products please contact us at the address below, or ask your nearest stockist.

For preventive maintenance, repair and calibration of all furnace and oven products, please contact:

Carbolite Gero Service

Telephone: + 44 (0) 1433 624242

Fax: +44 (0) 1433 624243

Email: ServiceUK@carbolite-gero.com

Carbolite Gero Ltd,

Parsons Lane, Hope, Hope Valley,
S33 6RB, England.

Telephone: + 44 (0) 1433 620011

Fax: + 44 (0) 1433 621198

Email: Info@carbolite-gero.com

www.carbolite-gero.com

CARBOLITE
GERO 30-3000°C

Copyright © 2020 Carbolite Gero Limited